



A systematic methodology for controller tuning in wastewater treatment plants

Mauricio Iglesias, Miguel; Jørgensen, Sten Bay; Sin, Gürkan

Publication date:
2012

Document Version
Publisher's PDF, also known as Version of record

[Link back to DTU Orbit](#)

Citation (APA):

Mauricio Iglesias, M., Jørgensen, S. B., & Sin, G. (2012). A systematic methodology for controller tuning in wastewater treatment plants. Poster session presented at 8th IFAC Symposium on Advanced Control of Chemical Processes, Singapore, Singapore.

General rights

Copyright and moral rights for the publications made accessible in the public portal are retained by the authors and/or other copyright owners and it is a condition of accessing publications that users recognise and abide by the legal requirements associated with these rights.

- Users may download and print one copy of any publication from the public portal for the purpose of private study or research.
- You may not further distribute the material or use it for any profit-making activity or commercial gain
- You may freely distribute the URL identifying the publication in the public portal

If you believe that this document breaches copyright please contact us providing details, and we will remove access to the work immediately and investigate your claim.

Controller tuning in wastewater treatment plants

Miguel Mauricio-Iglesias
Sten Bay Jørgensen
Gürkan Sin

DTU Chemical Engineering
Department of Chemical and Biochemical Engineering

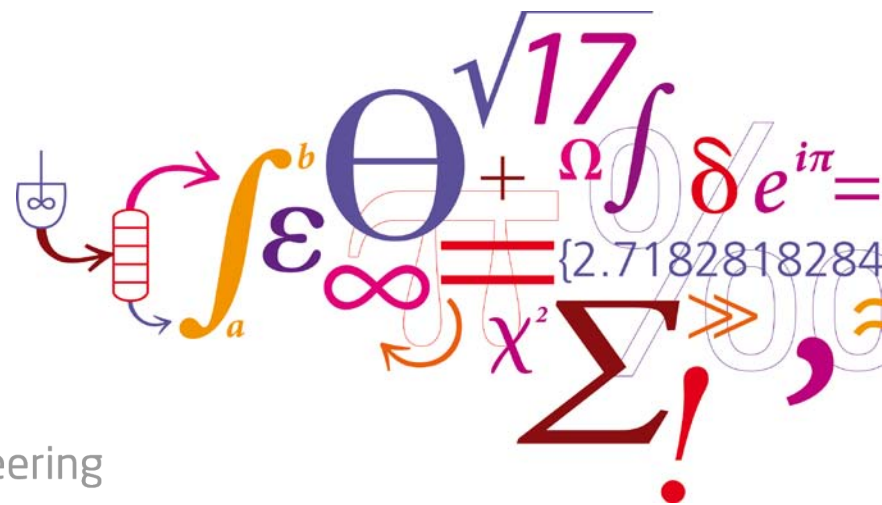

Introduction and motivation

Tuning a control loop is the adjustment of its control parameters to the optimum values for the desired control response

There is a large number of methods that can be used for tuning.

O'Dwyer, A. *Handbook of Controller Tuning Rules*

Åström, K. J. and Hägglund, T. *PID Controllers: Theory, Design and Tuning*

Wastewater treatment plants (WWTP) can be tuned according to any of those methods. They use mostly PI controllers

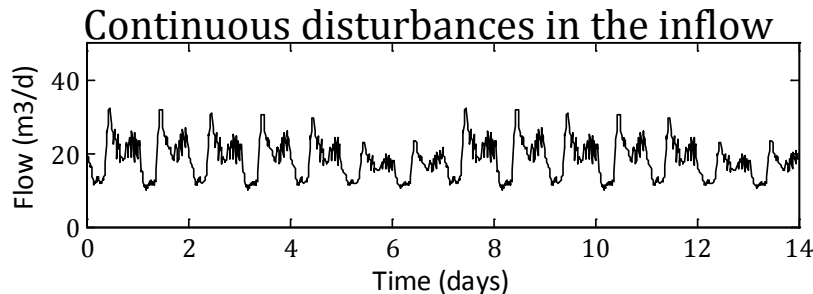

The purpose of this contribution is to use process engineering knowledge of WWTP and its influent dynamics to improve the tuning of the controllers!

Overview of the presentation

- 1) Presentation of the WWTP
- 2) Methodology. Example
- 3) Process review
- 4) Open loop analysis
- 5) Closed loop design
- 6) Evaluation
- 7) Conclusion

Model WWTP

Benchmark simulation model 1

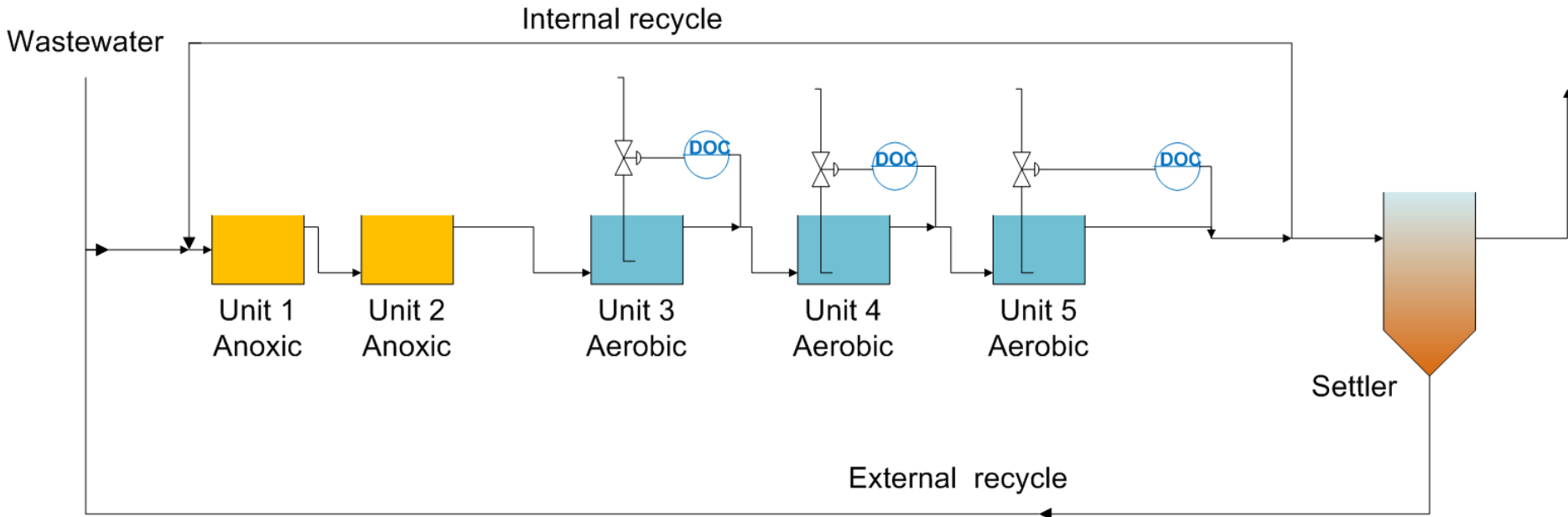

Provide basic information about the plant capacity.

Typically flow rate

Typical effluent requirement.

Etc. This is

Methodology

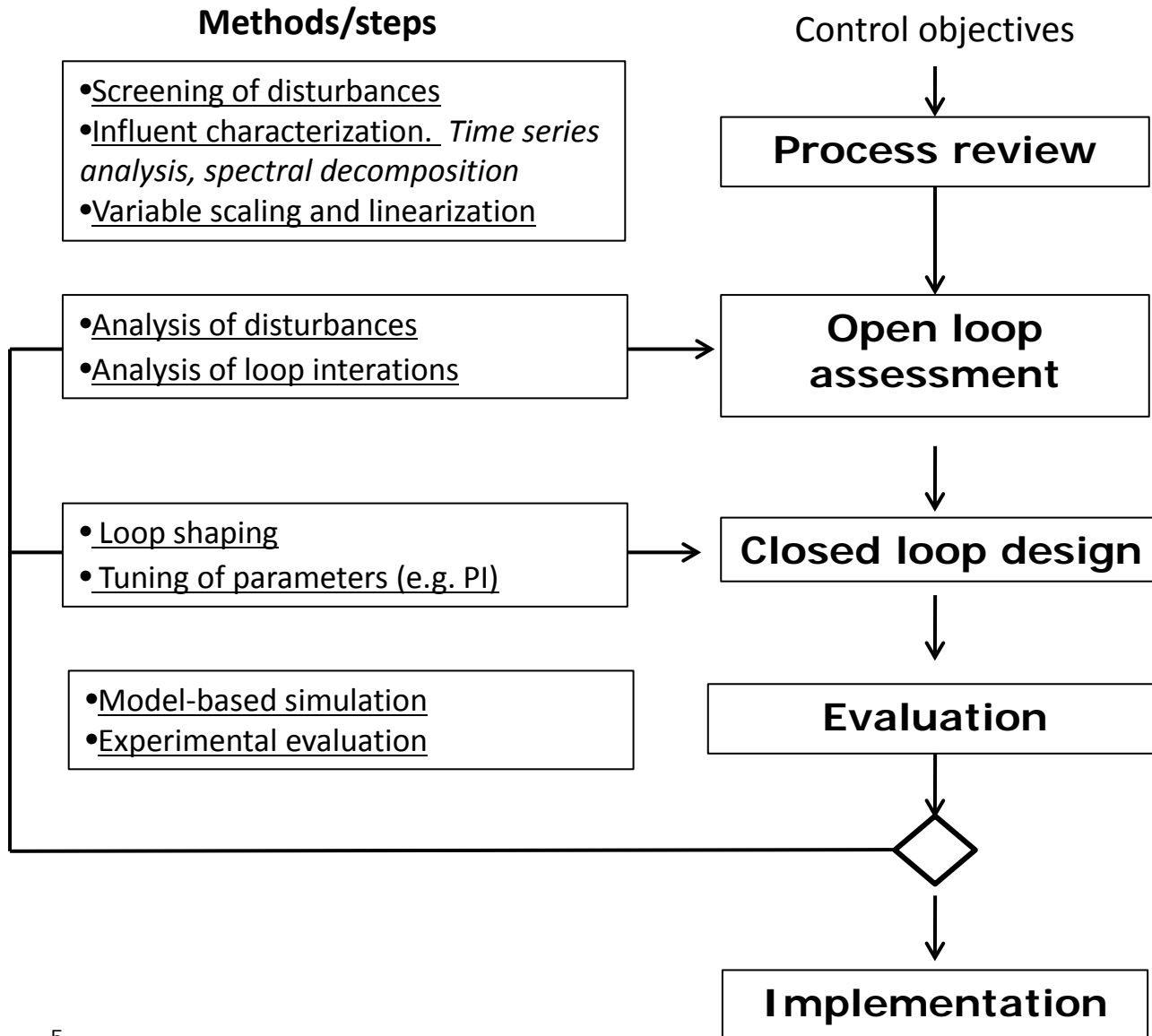

Methodology

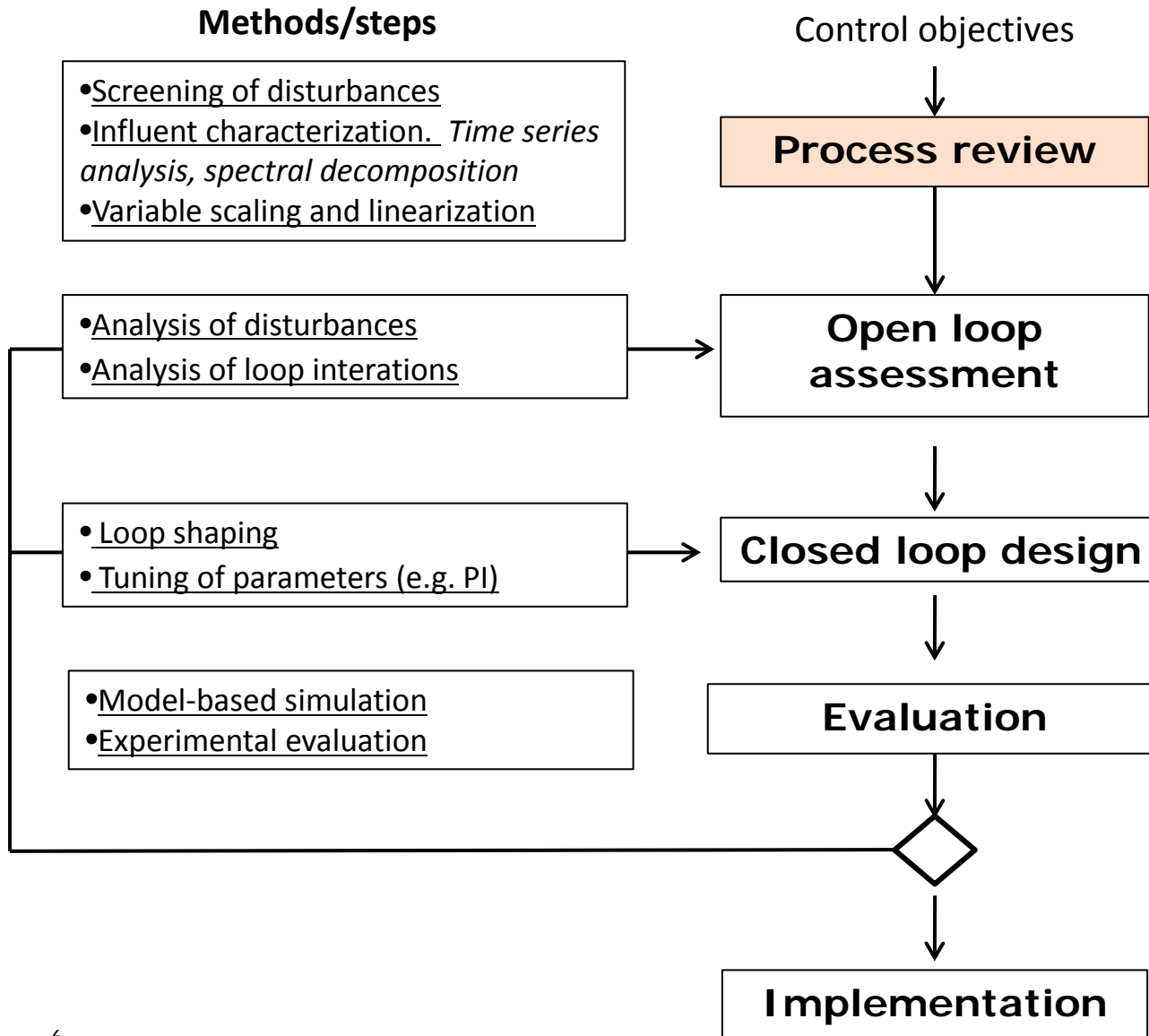

Process review. Screening of disturbances



Wastewater

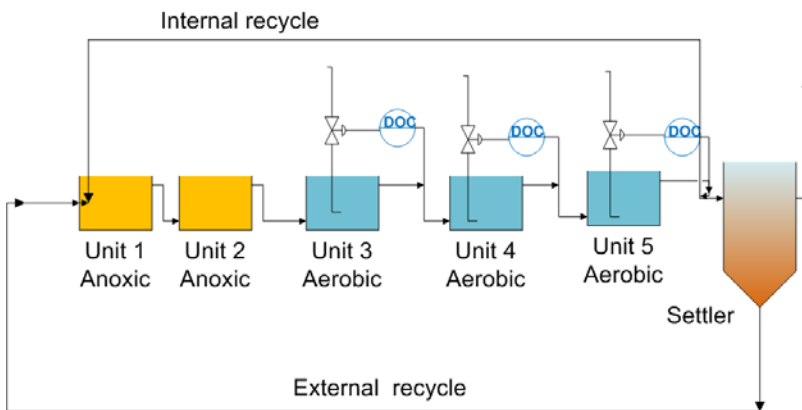

11 variables

- soluble inert organic matter S_I
- readily biodegradable substrate S_S
- particulate inert organic matter X_I
- slowly biodegradable substrate X_S
- active heterotrophic biomass X_{BH}
- total ammonium nitrogen S_{NH}
- soluble biodegradable organic nitrogen S_{ND}
- part. biodegradable organic nitrogen X_{ND}
- alkalinity S_{ALK}
- total suspended solids T_{SS}
- total flowrate Q

Process review. Screening of disturbances



Wastewater

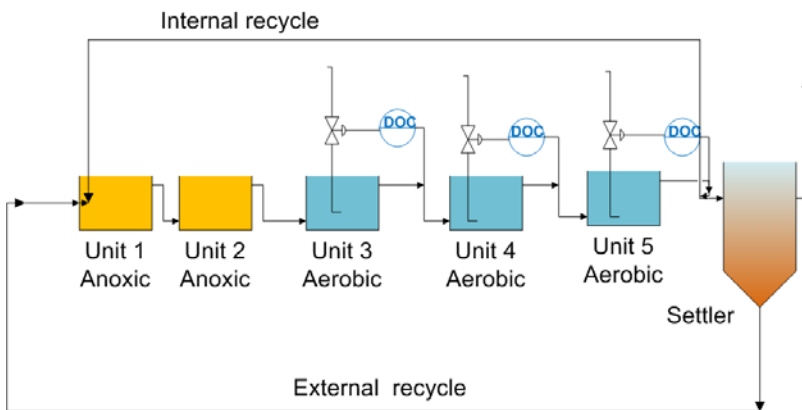

11 variables

- soluble inert organic matter S_I
- readily biodegradable substrate** S_S
- particulate inert organic matter** X_I
- slowly biodegradable substrate** X_S
- active heterotrophic biomass X_{BH}
- total ammonium nitrogen** S_{NH}
- soluble biodegradable organic nitrogen S_{ND}
- part. biodegradable organic nitrogen X_{ND}
- alkalinity S_{ALK}
- total suspended solids** T_{SS}
- total flowrate** Q

Process review. Influent characterization & dynamics

Dry weather

Daily pattern

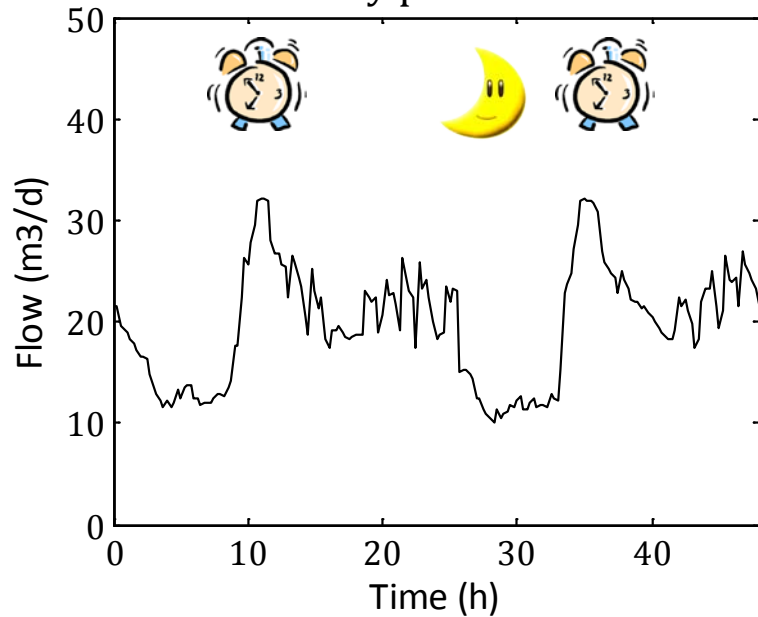

Weekly pattern

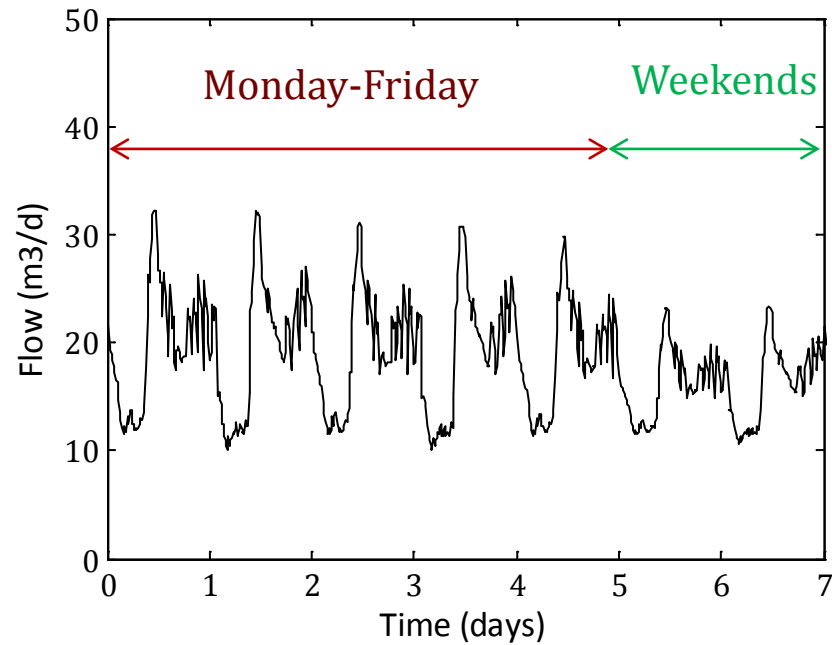

Process review. Influent characterization

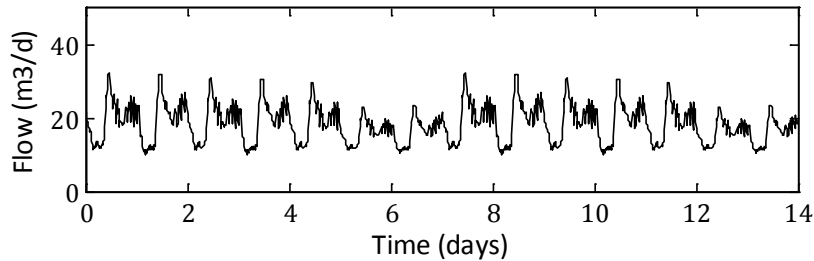

Spectral decomposition

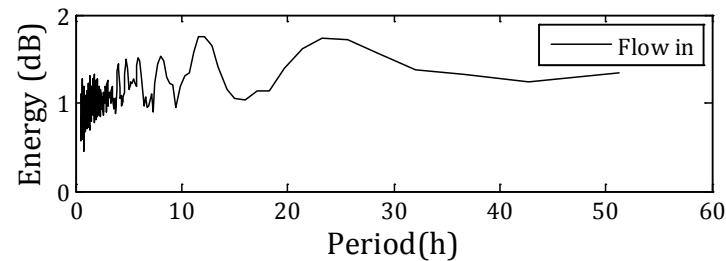
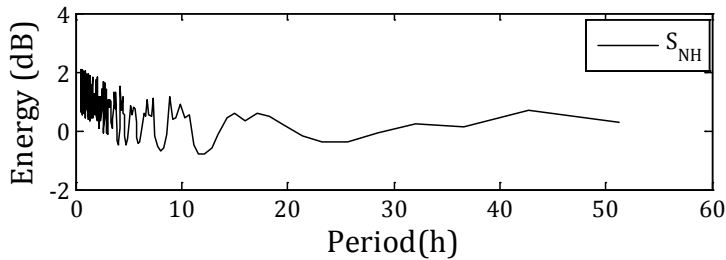

Main periods associated with influent dynamics

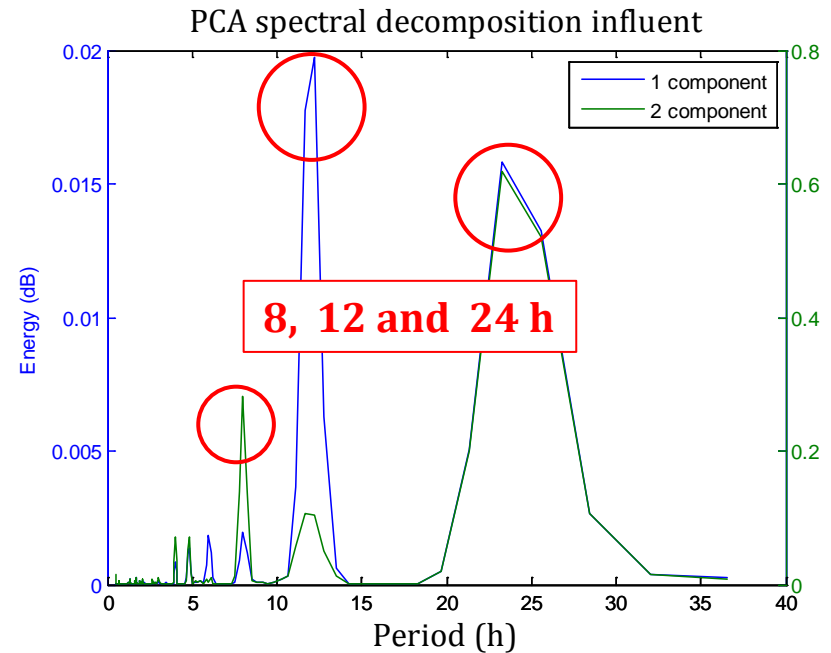

Principal component analysis

Process review. Variable scaling

A number of criteria used depend critically on the scaling

Disturbances (d_{\max}-d_{\min}) for dry weather, rain and storm weather	Var.	S_I (g COD m ⁻³)	S_S (g COD m ⁻³)	X_I (g COD m ⁻³)	
	Value	30	65.2	45.6	
	Var.	X_S (g COD m ⁻³)	X_{BH} (g COD m ⁻³)	S_{NH} (g N m ⁻³)	
	Value	193	26.5	30.1	
	Var.	S_{ND} (g N m ⁻³)	X_{ND} (g N m ⁻³)	S_{ALK} (mol m ⁻³)	
	Value	6.5	10	7	
	Var.	T_{SS} (g COD m ⁻³)	Q (m ³ d ⁻¹)		
	Value	199	18446		
CVs	Δy_{\max}	Var.	D_{O3} (g O m ⁻³)	D_{O4} (g O m ⁻³)	D_{O5} (g O m ⁻³)
		Value	0.1	0.1	0.1
MVs	$(u_{\max}-u_{\min})$	Var.	kLa_3 (d ⁻¹)	kLa_4 (d ⁻¹)	kLa_5 (d ⁻¹)
		Value	360	360	360

Process review. Plant linearisation

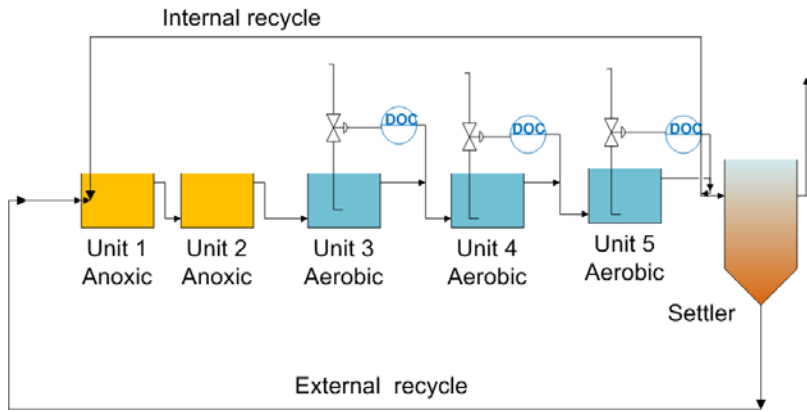

$$G = \begin{matrix} DO_3 \\ DO_4 \\ DO_5 \end{matrix} \frac{1}{13.8s + 1} \begin{bmatrix} kla_3 & kla_4 & kla_5 \\ 47.9 & 0.92 & 1.97 \\ 16.7 & 67.1 & 5.64 \\ 15.8 & 31.7 & 103 \end{bmatrix}$$

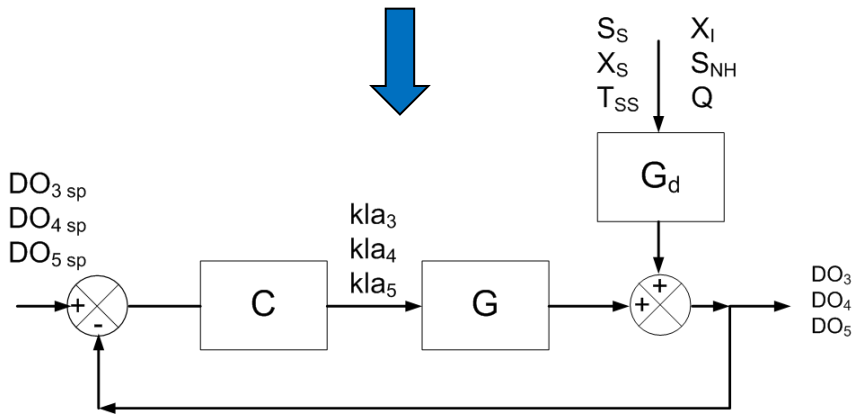

Full linear model (96 states)

Reduced linear model (1 state)

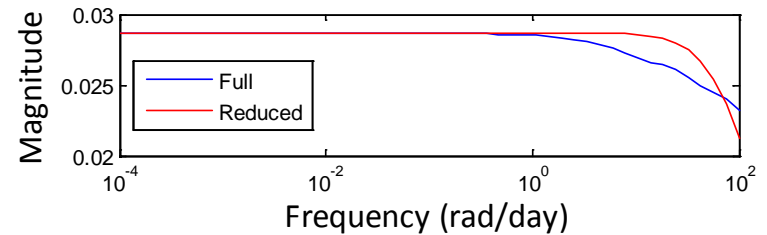
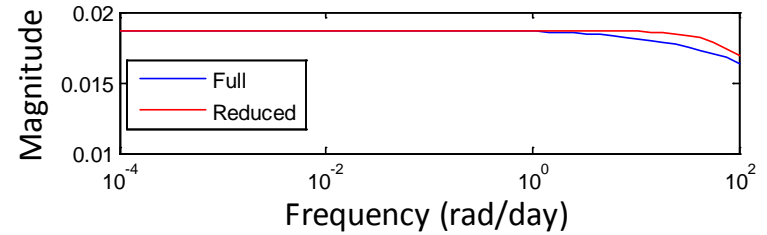
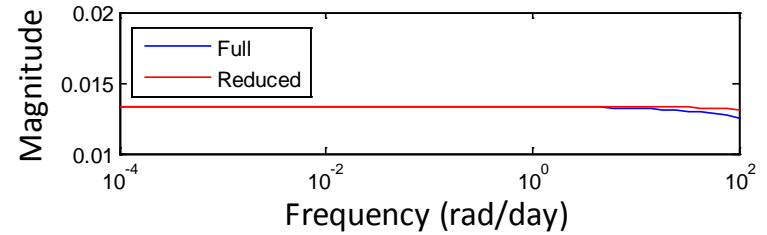

Methodology

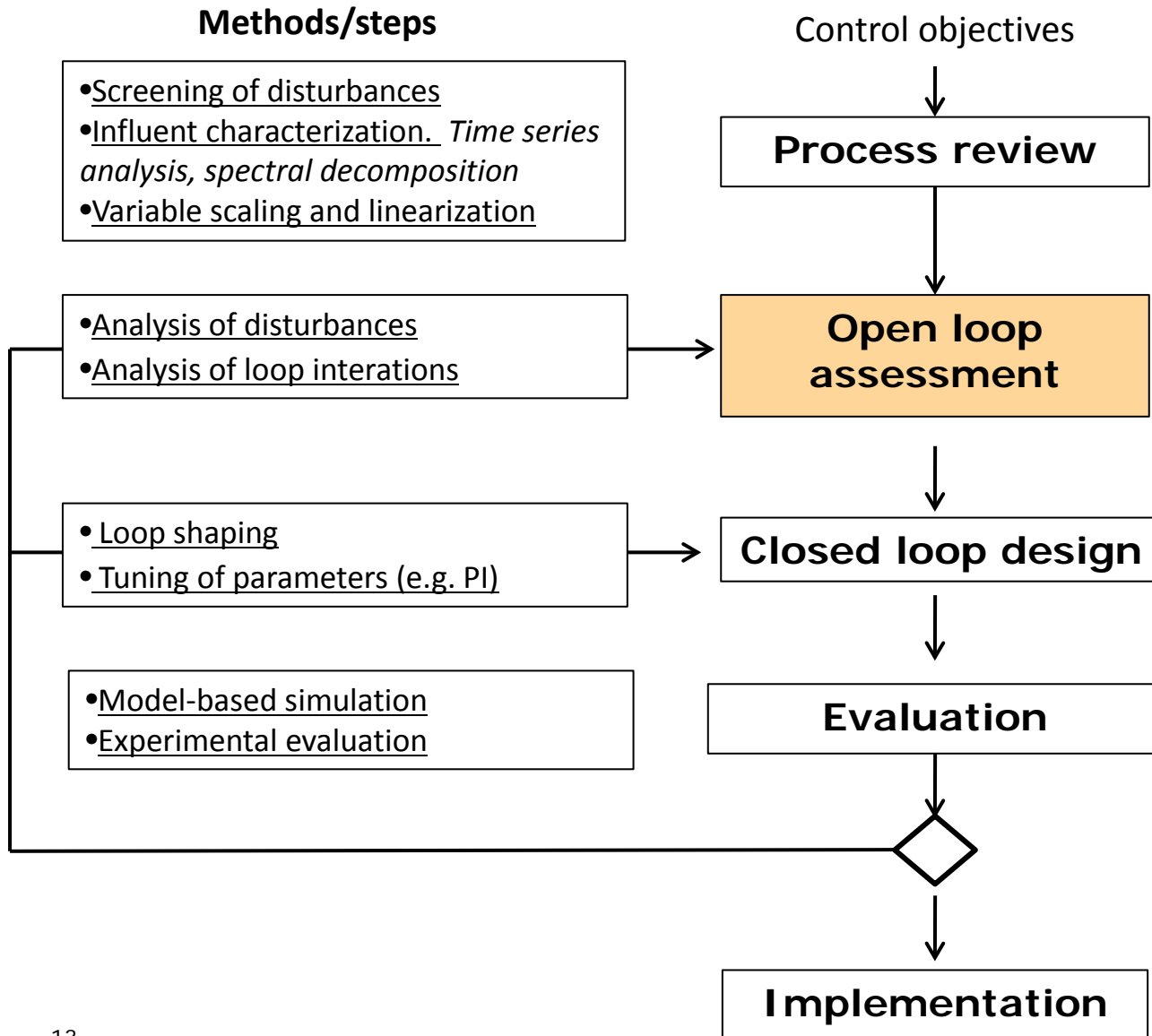

Open loop assessment. Disturbances

Closed Loop Disturbance Gain (CLDG)

$$CDLG = \tilde{G}_{(s)} G^{-1}_{(s)} G_d(s)$$

$$CLDG = |\delta_i| < 1$$

The disturbance effect is lower than Δy_{\max}

$$CLDG = |\delta_i| > 1$$

The disturbance effect is higher than Δy_{\max}

Need of control action!

$$|g_i c_i| > |\delta_i|$$

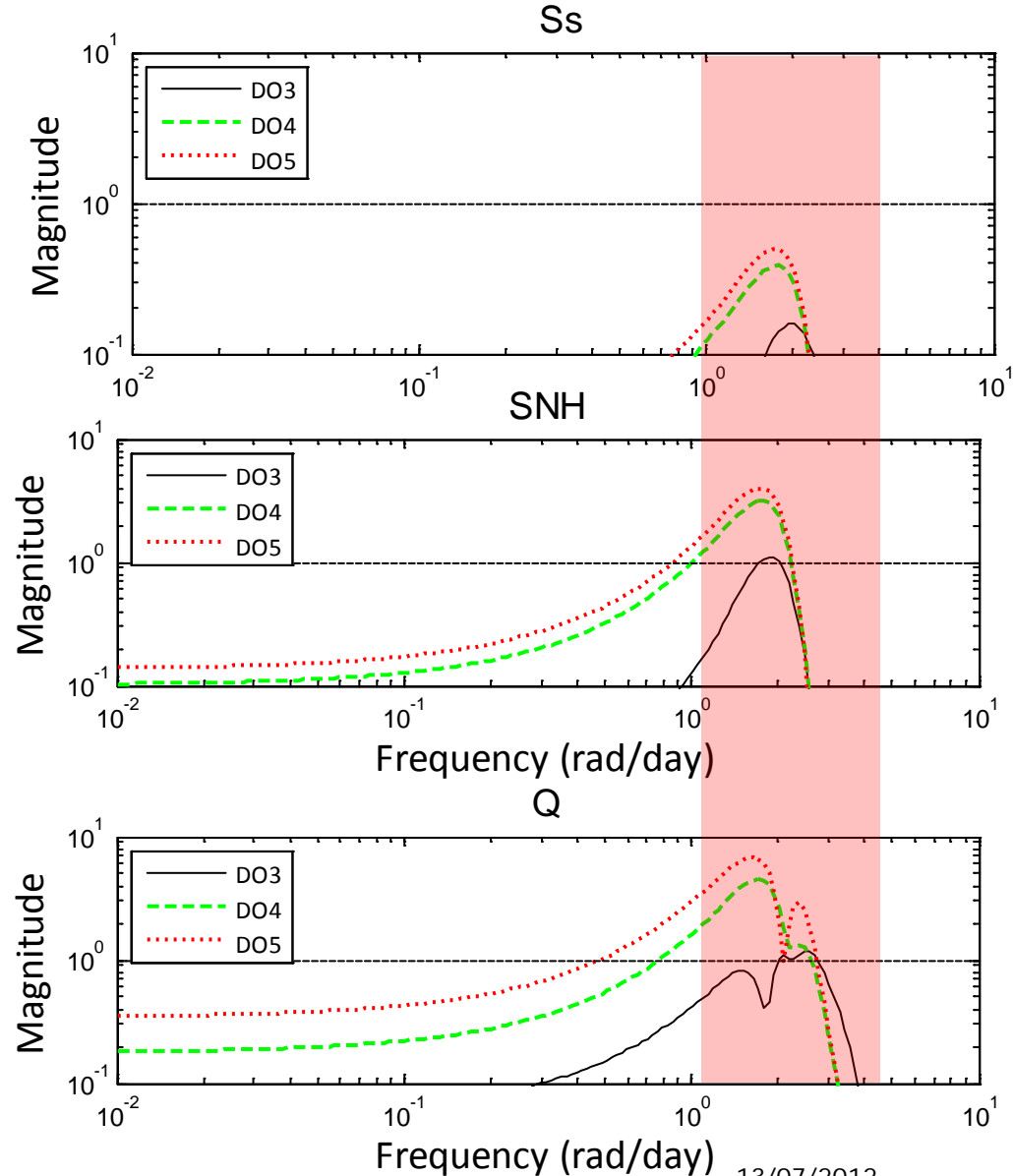

Open loop assessment. Interactions

Relative Gain Array (RGA)

$$\lambda_{ij} = \frac{\left(\frac{\partial y_i}{\partial u_j} \right) \Big|_{u_k=0, k \neq j}}{\left(\frac{\partial y_i}{\partial u_j} \right) \Big|_{y_k=0, k \neq i}}$$

$$\lambda_{ij} = \frac{\text{Open loop gain}}{\text{Closed loop gain}}$$

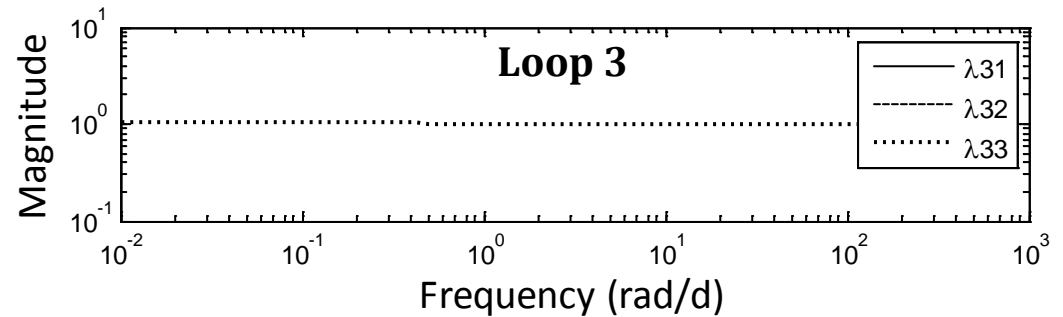
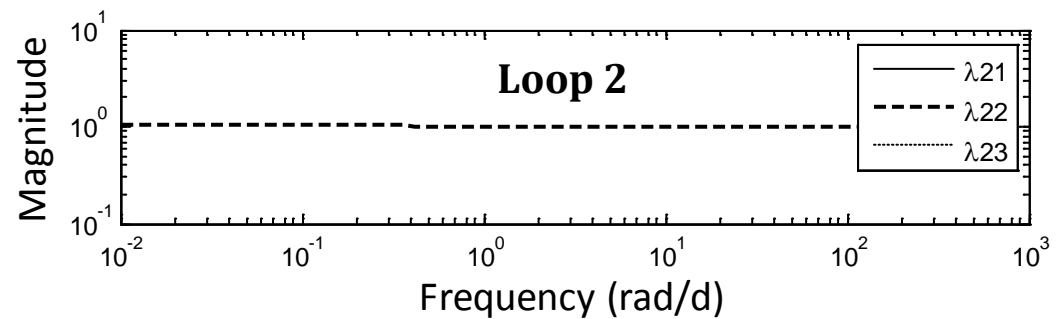
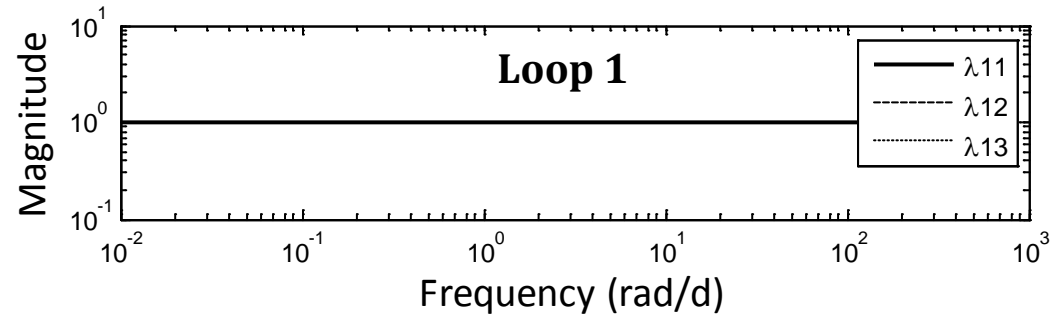

Process review. Plant linearisation

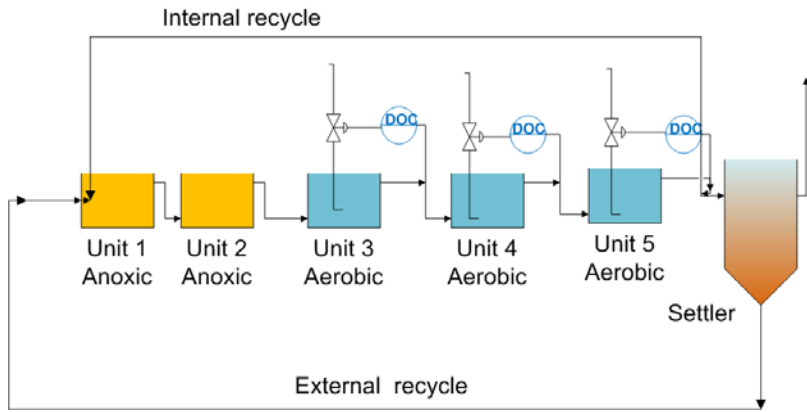

$$G = \begin{matrix} DO_3 \\ DO_4 \\ DO_5 \end{matrix} \frac{1}{13.8s + 1} \begin{bmatrix} kla_3 & kla_4 & kla_5 \\ 47.9 & 0.92 & 1.97 \\ 16.7 & 67.1 & 5.64 \\ 15.8 & 31.7 & 103 \end{bmatrix}$$

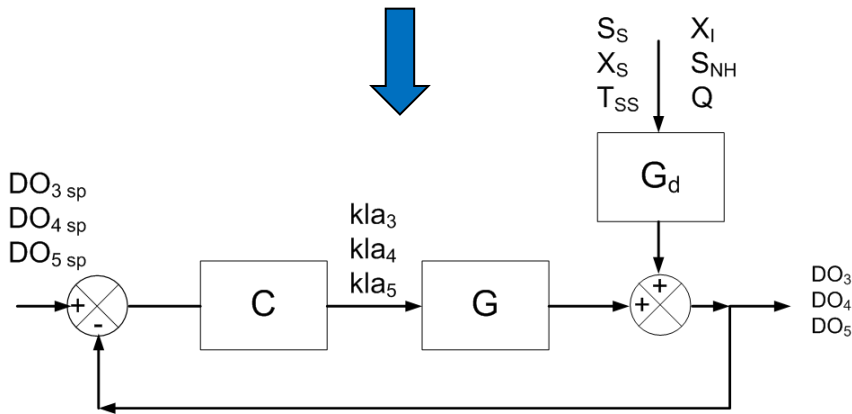

Full linear model (96 states)

Reduced linear model (1 state)

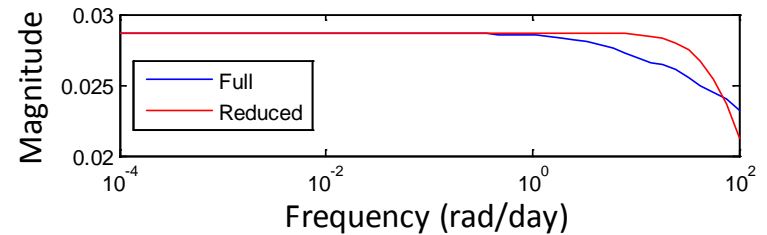
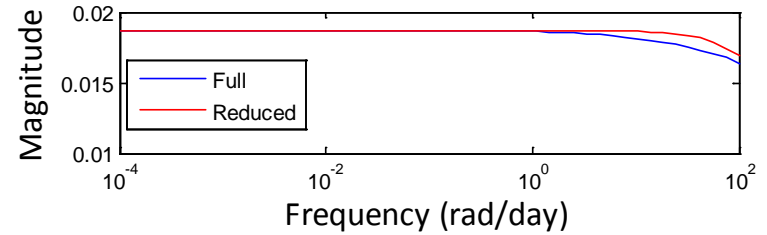
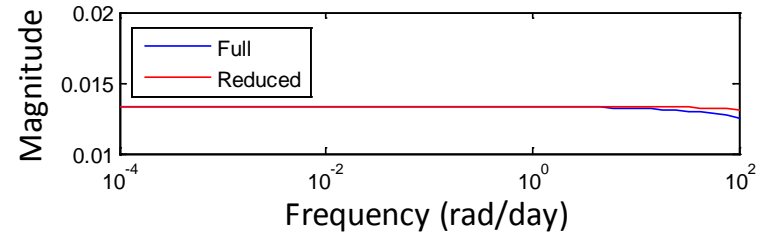

Open loop assessment. Interactions

Performance Relative Gain Array (PRGA)

$$PRGA = \Gamma = \tilde{G}_{(s)} G^{-1}_{(s)}$$

☹️ Dependent on scaling

😊 Suitable for one-way interactions

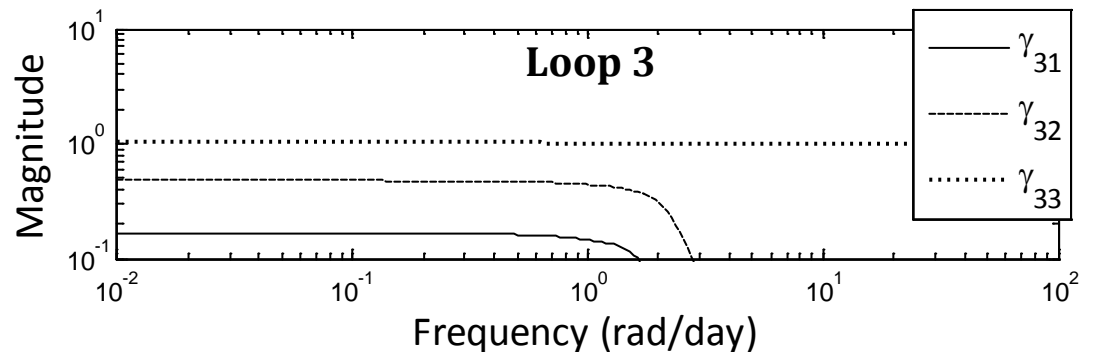
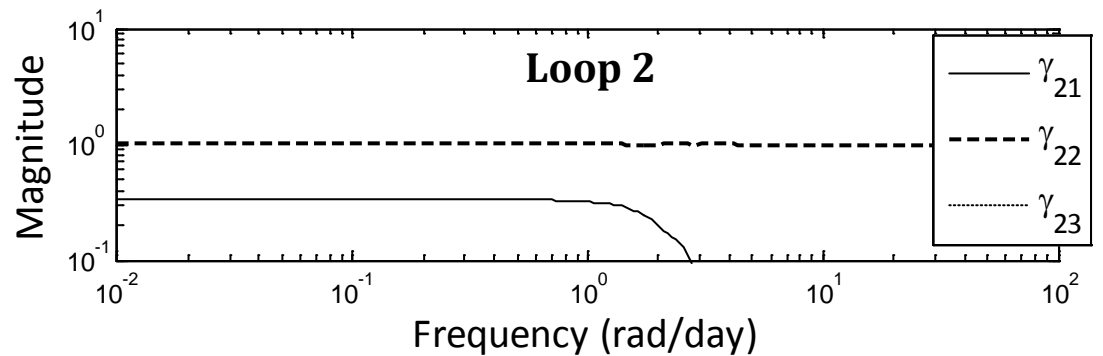
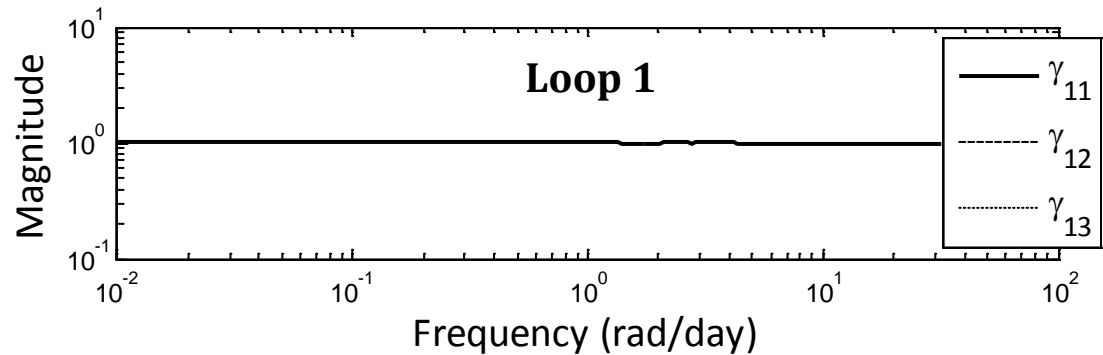

Methodology

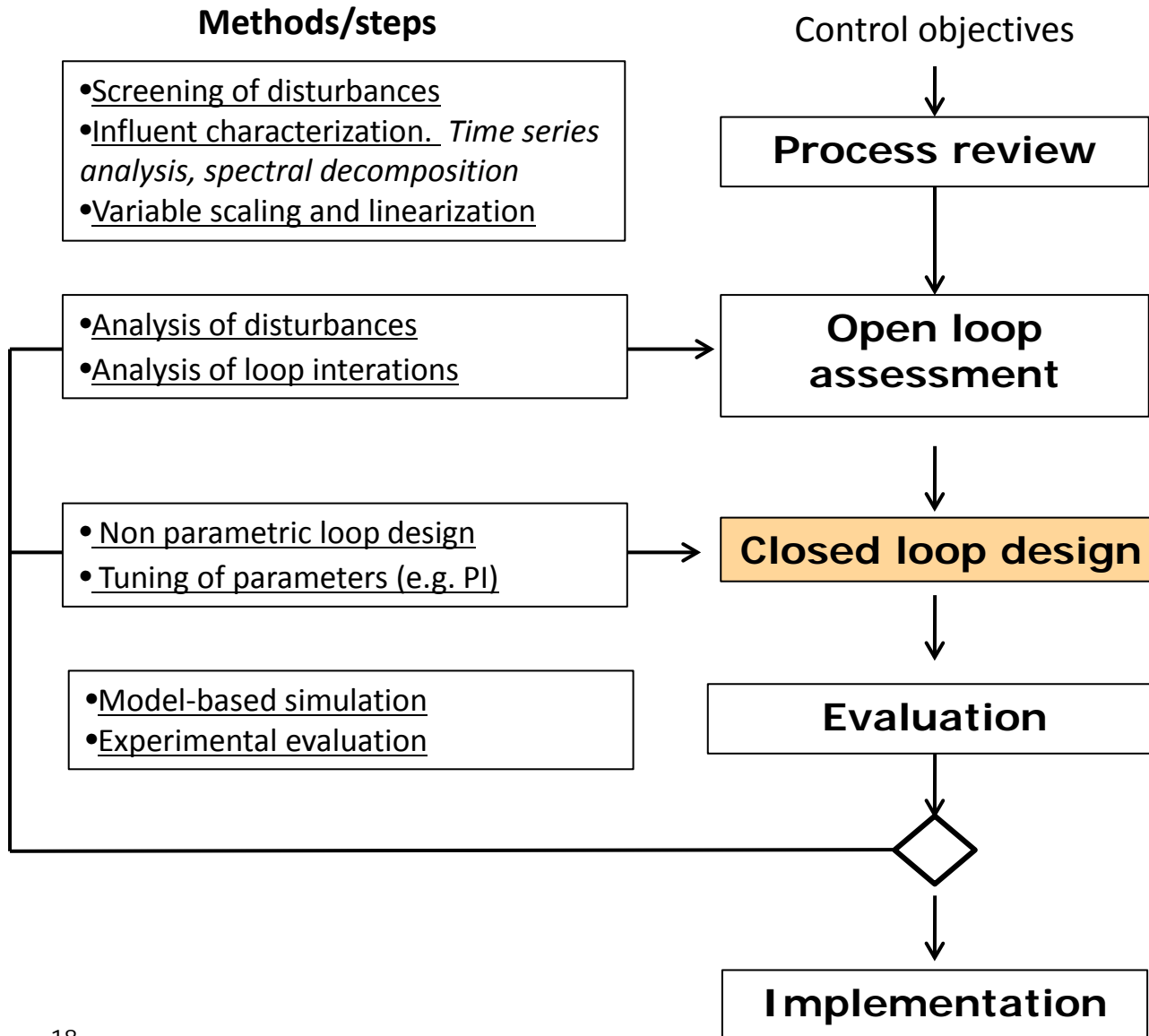

Closed loop design. Analysis of tuning parameters

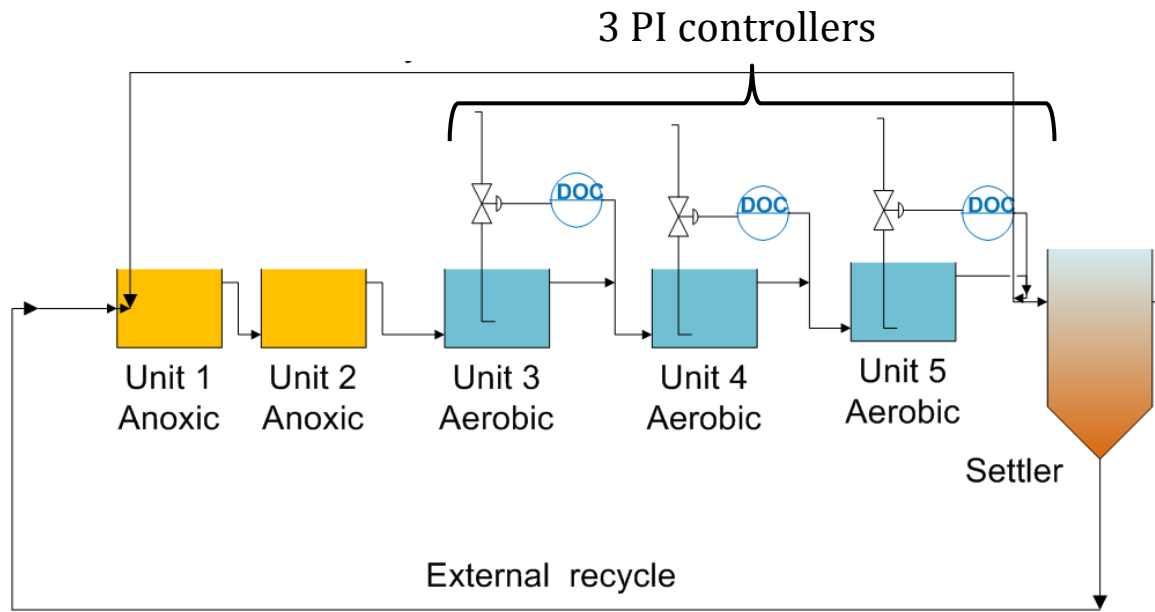

Reported parameters

Vanrolleghem and Gillot 2002

	Loop 1	Loop 2	Loop 3
K_p	0.028	0.028	0.028
τ_I (min)	14.4	14.4	14.4

Closed loop design. Analysis of tuning parameters

CLDG = $|\delta_i| > 1$ at some frequencies

$|g_i c_i| > |\delta_i|$?

CLDG for flow disturbance

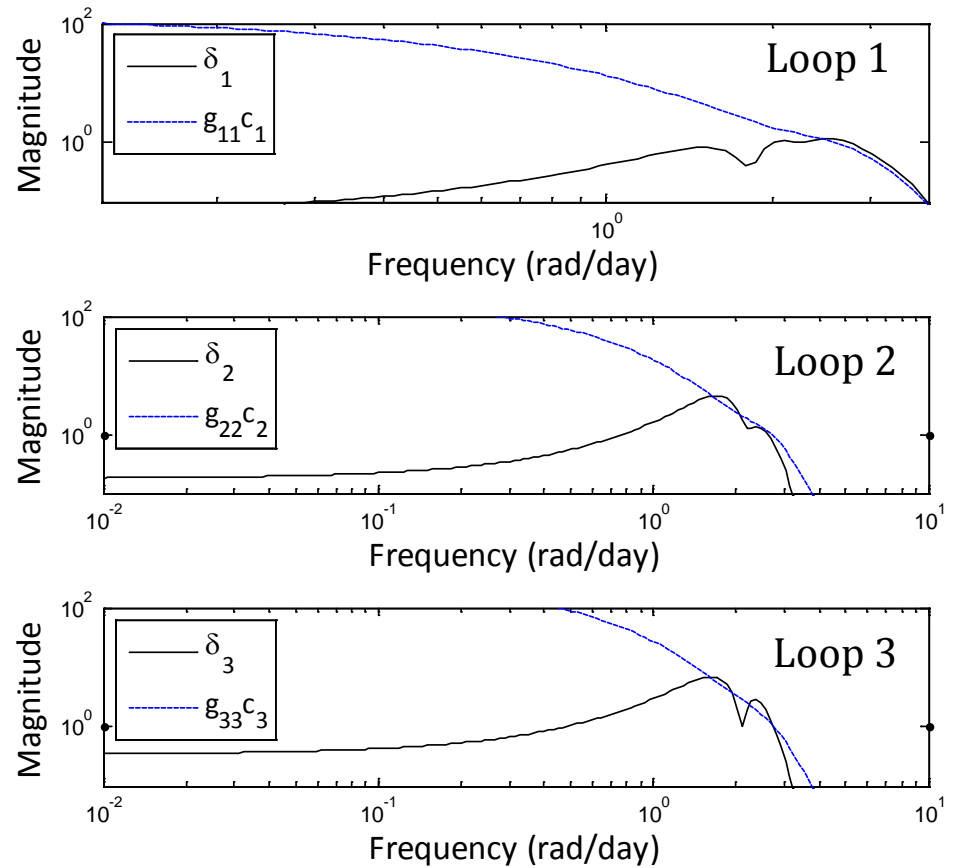

Closed loop design. New tuning parameters

$$\min |M_S|_{\infty} = f(K_p, \tau_I)$$

$$\text{for } S(s) = \frac{I}{I + G(s)C(s)}$$

$$\text{s.t. } |g_i c_i| > 1.10 |\delta_i| \quad \text{for } \omega < \omega_B$$

New parameters

	Loop 1	Loop 2	Loop 3
K_p	0.056	0.056	0.056
τ_I (min)	10.1	10.1	10.1

CLDG for flow disturbance

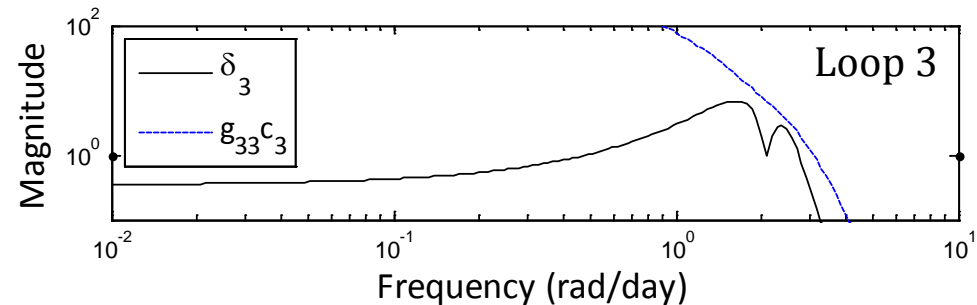
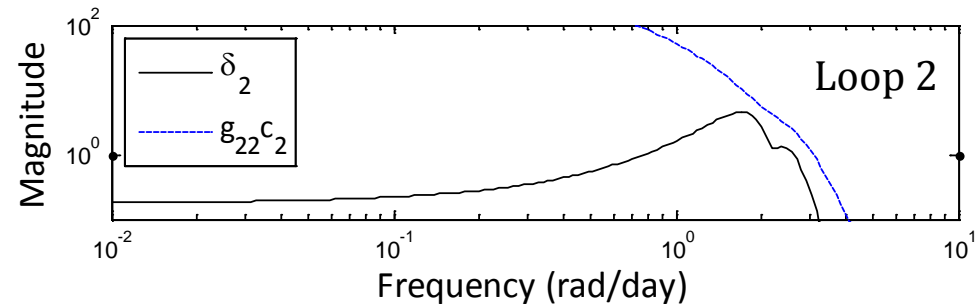
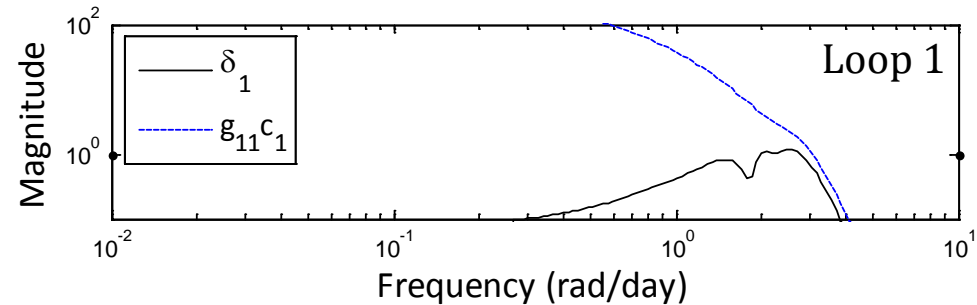

Methodology

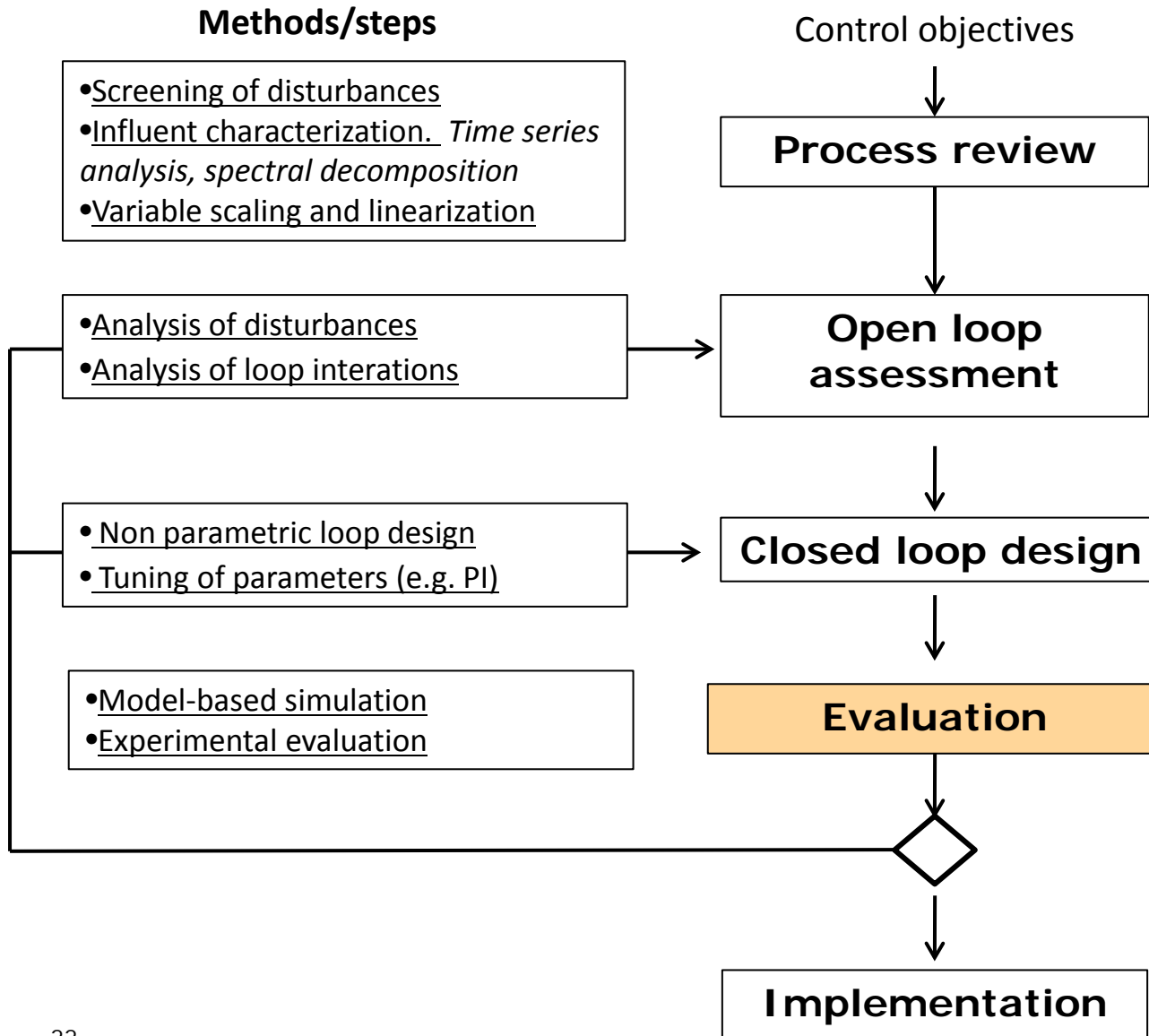

Evaluation

7 days dry weather + 7 days storm weather

$$IAE = \int_0^{\infty} |DO - DO^{sp}| dt$$

$$TV = \sum_{i=1}^{\infty} |kla_{i+1} - kla_i|$$

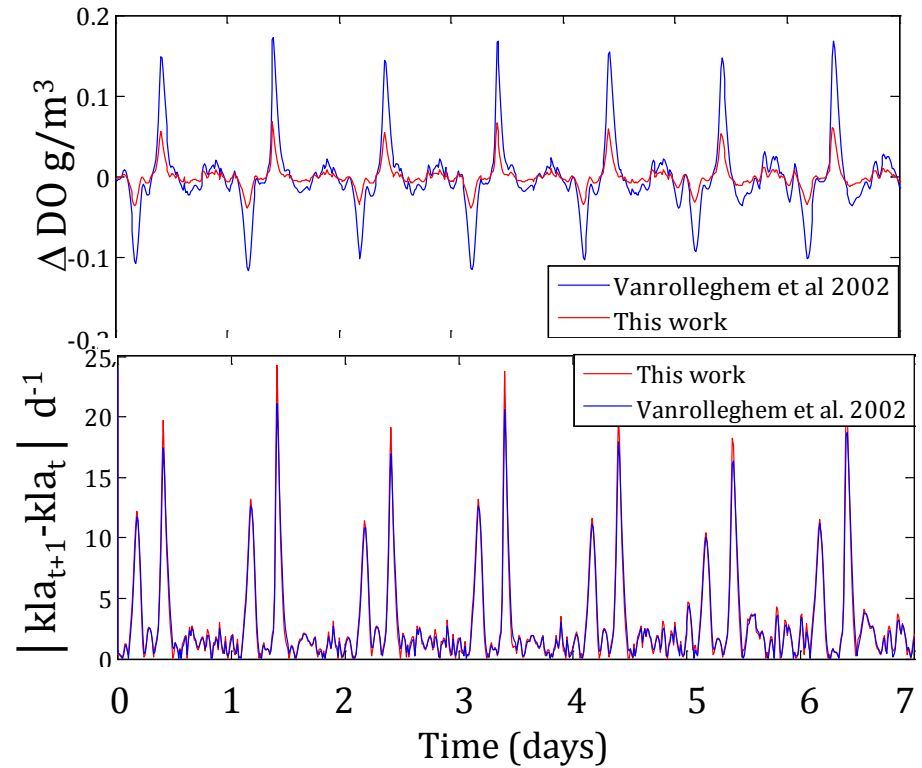

Evaluation

7 days dry weather + 7 days storm weather

$$IAE = \int_0^{\infty} |DO - DO^{sp}| dt$$

$$TV = \sum_{i=1}^{\infty} |kla_{i+1} - kla_i|$$

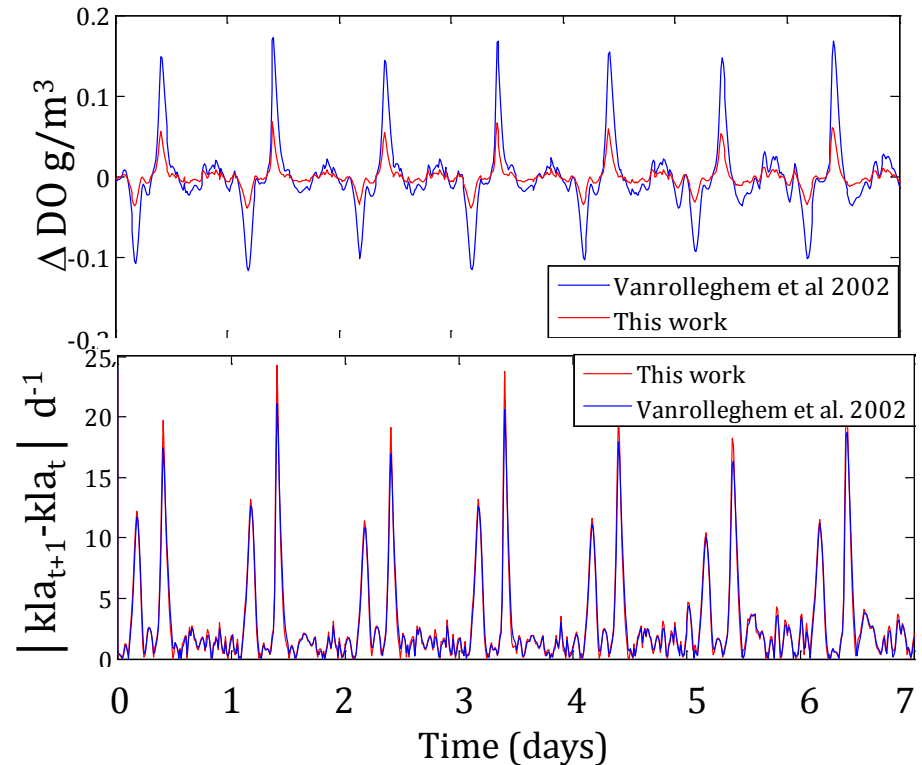

Integral of absolute error (mgO₂ d L⁻¹)

Total Variance of MV (d⁻¹)

	DO ₃	DO ₄	DO ₅	kLa ₃	kLa ₄	kLa ₅
Dryweather influent						
Vanrolleghem & Gillot ₍₂₀₀₂₎	0.190	0.326	0.315	14.0	31.5	31.3
This work	0.020	0.034	0.032	16.1	35.1	34.7
Storm weather influent						
Vanrolleghem & Gillot ₍₂₀₀₂₎	0.193	0.313	0.323	13.2	31.5	33.3
This work	0.021	0.032	0.033	15.3	31.5	33.3

Evaluation

7 days dry weather + 7 days storm weather

$$IAE = \int_0^{\infty} |DO - DO^{sp}| dt$$

$$TV = \sum_{i=1}^{\infty} |kla_{i+1} - kla_i|$$

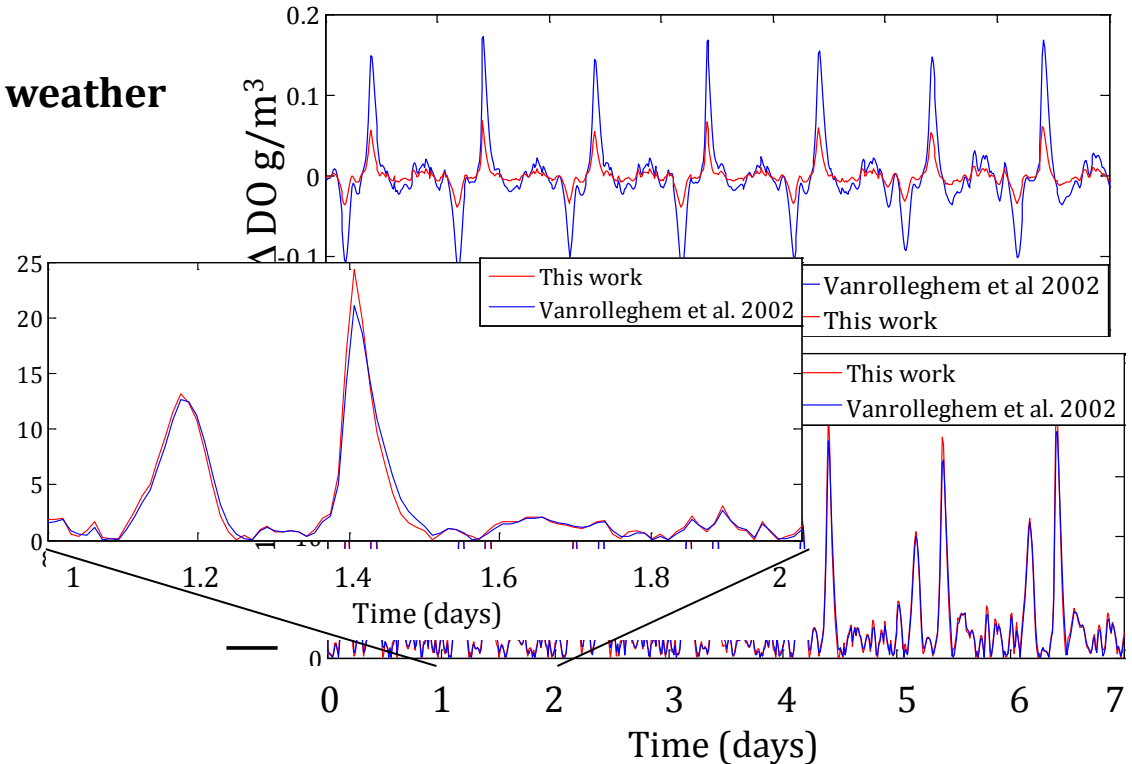

Integral of absolute error (mgO₂ d L⁻¹)

Total Variance of MV (d⁻¹)

	DO ₃	DO ₄	DO ₅	kLa ₃	kLa ₄	kLa ₅
Dryweather influent						
Vanrolleghem & Gillot ₍₂₀₀₂₎	0.190	0.326	0.315	14.0	31.5	31.3
This work	0.020	0.034	0.032	16.1	35.1	34.7
Storm weather influent						
Vanrolleghem & Gillot ₍₂₀₀₂₎	0.193	0.313	0.323	13.2	31.5	33.3
This work	0.021	0.032	0.033	15.3	31.5	33.3

Evaluation

7 days dry weather + 7 days storm weather

$$IAE = \int_0^{\infty} |DO - DO^{sp}| dt$$

$$TV = \sum_{i=1}^{\infty} |kla_{i+1} - kla_i|$$

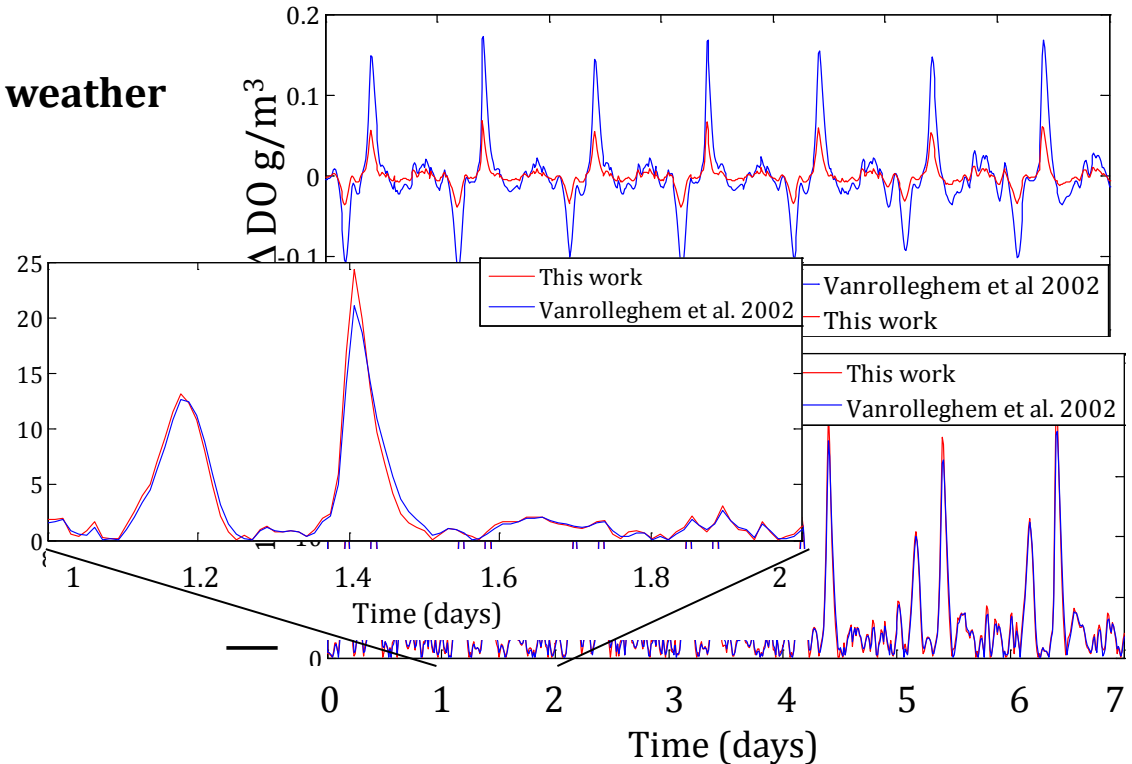

Integral of absolute error (mgO₂ d L⁻¹)

Total Variance of MV (d⁻¹)

	DO ₃	DO ₄	DO ₅	kLa ₃	kLa ₄	kLa ₅
Dryweather influent						
Vanrolleghem & Gillot ₍₂₀₀₂₎	0.190	0.326	0.315	14.0	31.5	31.3
This work	0.020	0.034	0.032	16.1	35.1	34.7
Storm weather influent						
Vanrolleghem & Gillot ₍₂₀₀₂₎	0.193	0.313	0.323	13.2	31.5	33.3
This work	0.021	0.032	0.033	15.3	31.5	33.3

Conclusions

We developed a **systematic methodology to formally approach** the tuning of controllers in WWTP

It takes into account the knowledge of **disturbances** in WWTP & user specified performance requirement (DCVs, deltatmax)

Information about the inflow is included to improve the tuning

It requires a model. Which is commonly used in WWTPs process design and operation.

It targets mainly existing plants but can be also used at design and planning stage.

The newly tuned controller showed **superior performance**

Some upcoming ideas...

Performance evaluation of the control structure including uncertainty, i.e. the combination of sensors and actuators, and how these relate to the control objectives

Controller tuning in wastewater treatment plants

Funded by Danish Agency for Science, Technology and Innovation through the Research Centre for Design of Microbial Communities in Membrane Bioreactors (09-067230) for funding of the project



Miguel Mauricio-Iglesias

Sten Bay Jørgensen

Gürkan Sin

mim@kt.dtu.dk

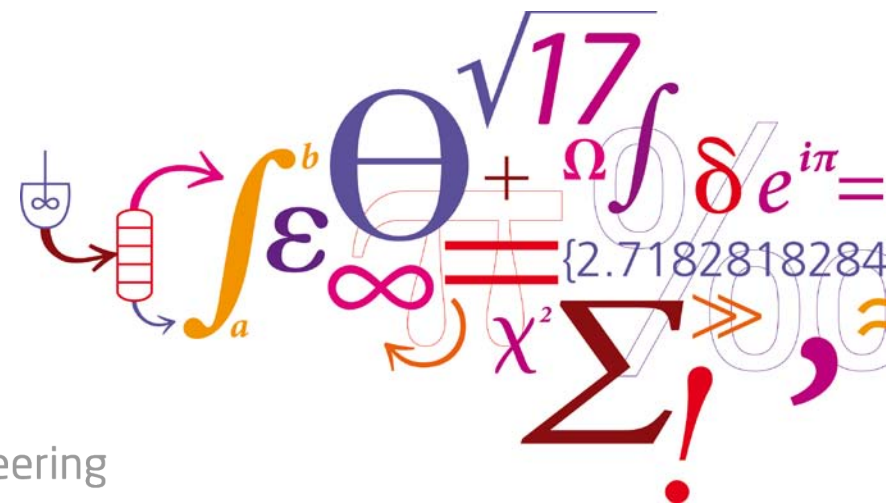

DTU Chemical Engineering

Department of Chemical and Biochemical Engineering
