

Lucas C. P. Cavalcante, J. J. Vegas Olmos, Idelfonso T. Monroy

Metro Access & Short-Range Communications, Department of Photonics Engineering, Technical University of Denmark
Ørsted Plads, Building 358-Room 109, Lyngby, 2800, Denmark

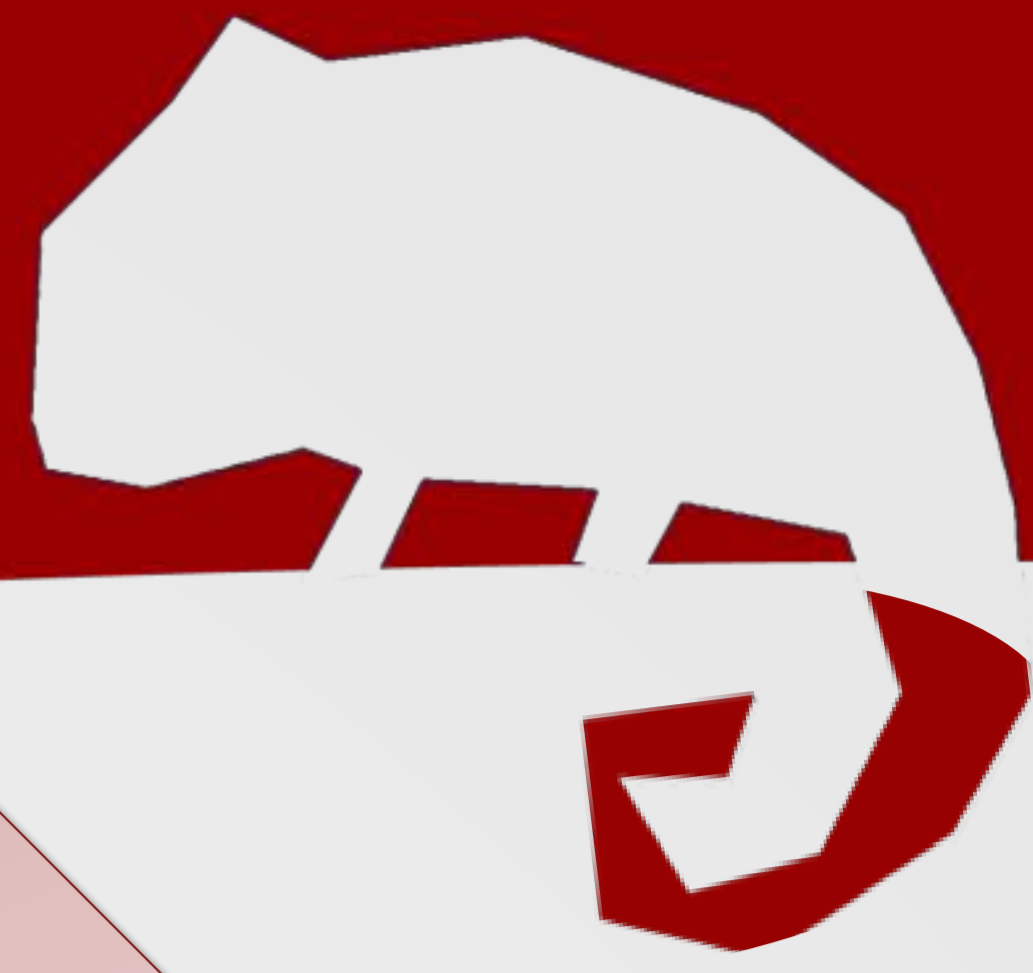

luca@fotonik.dtu.dk

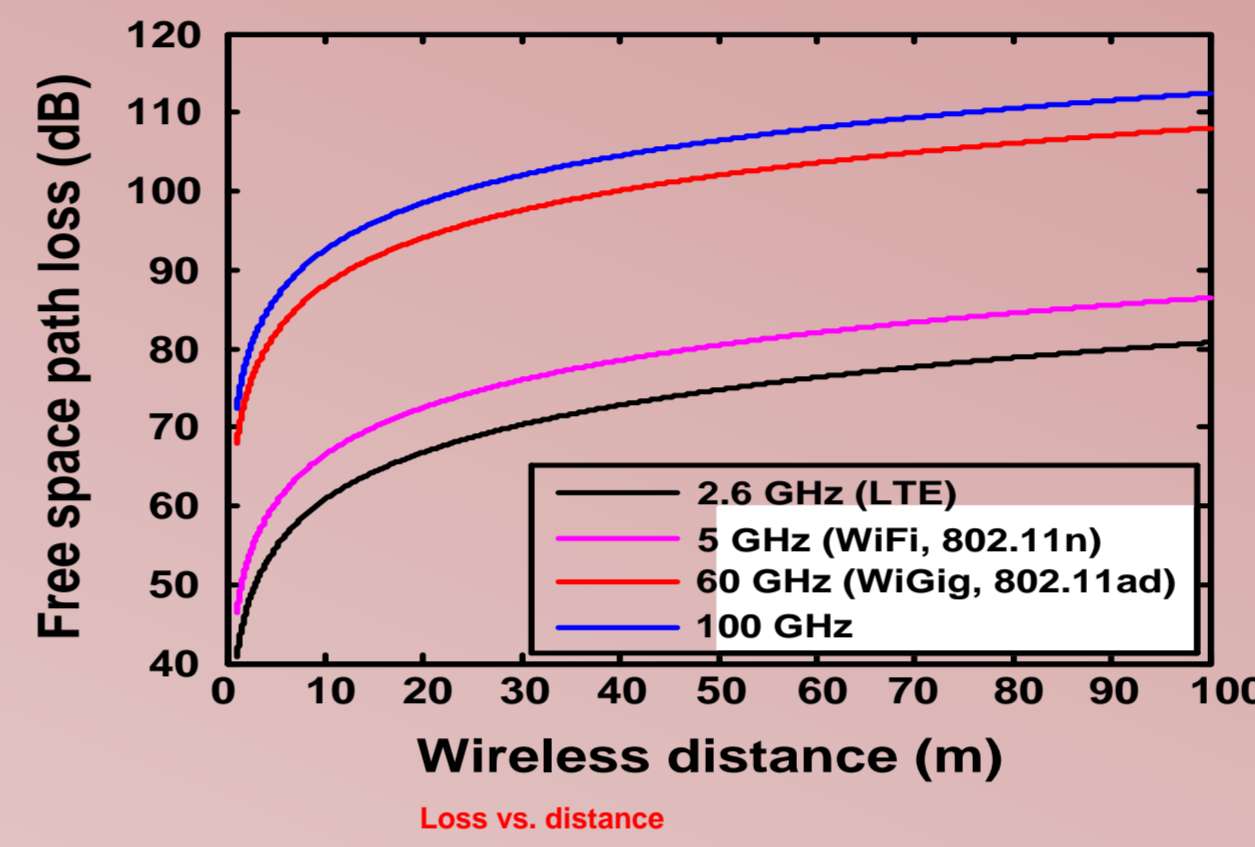
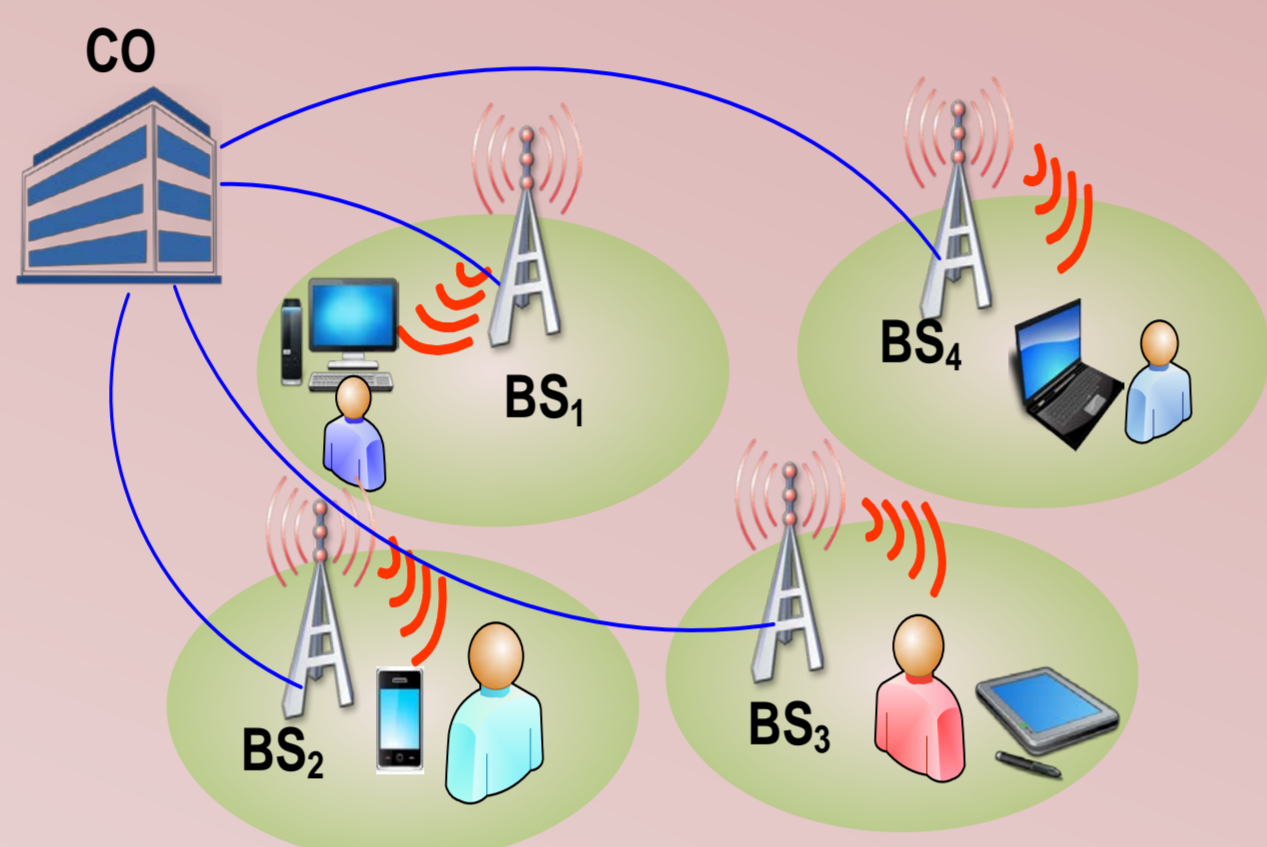
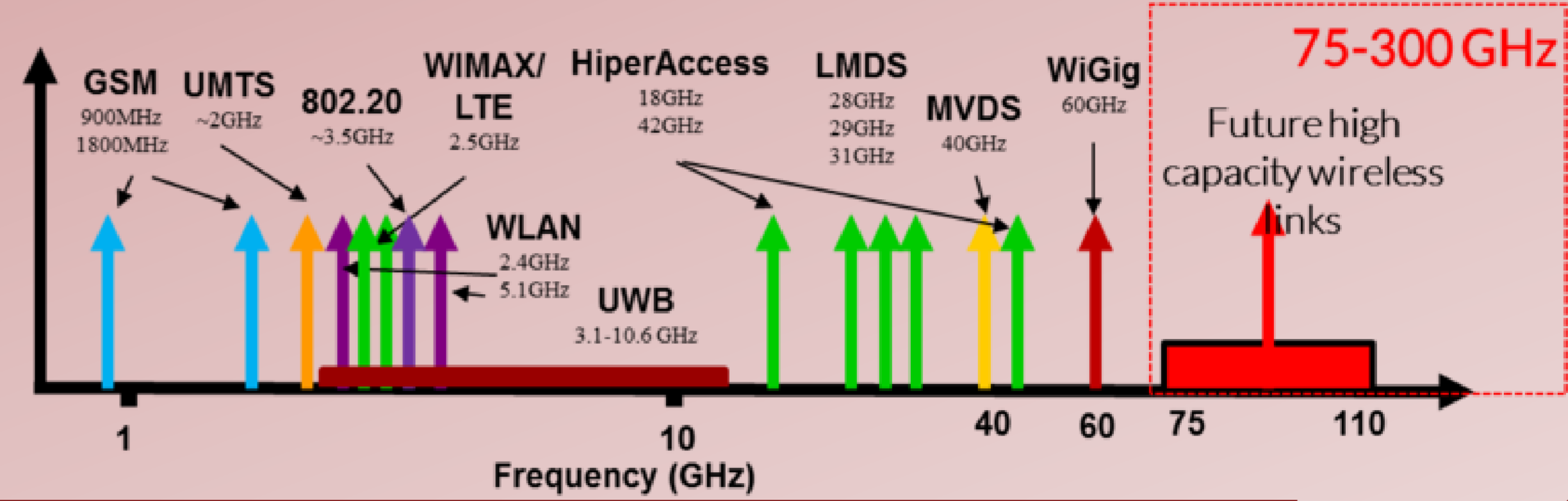
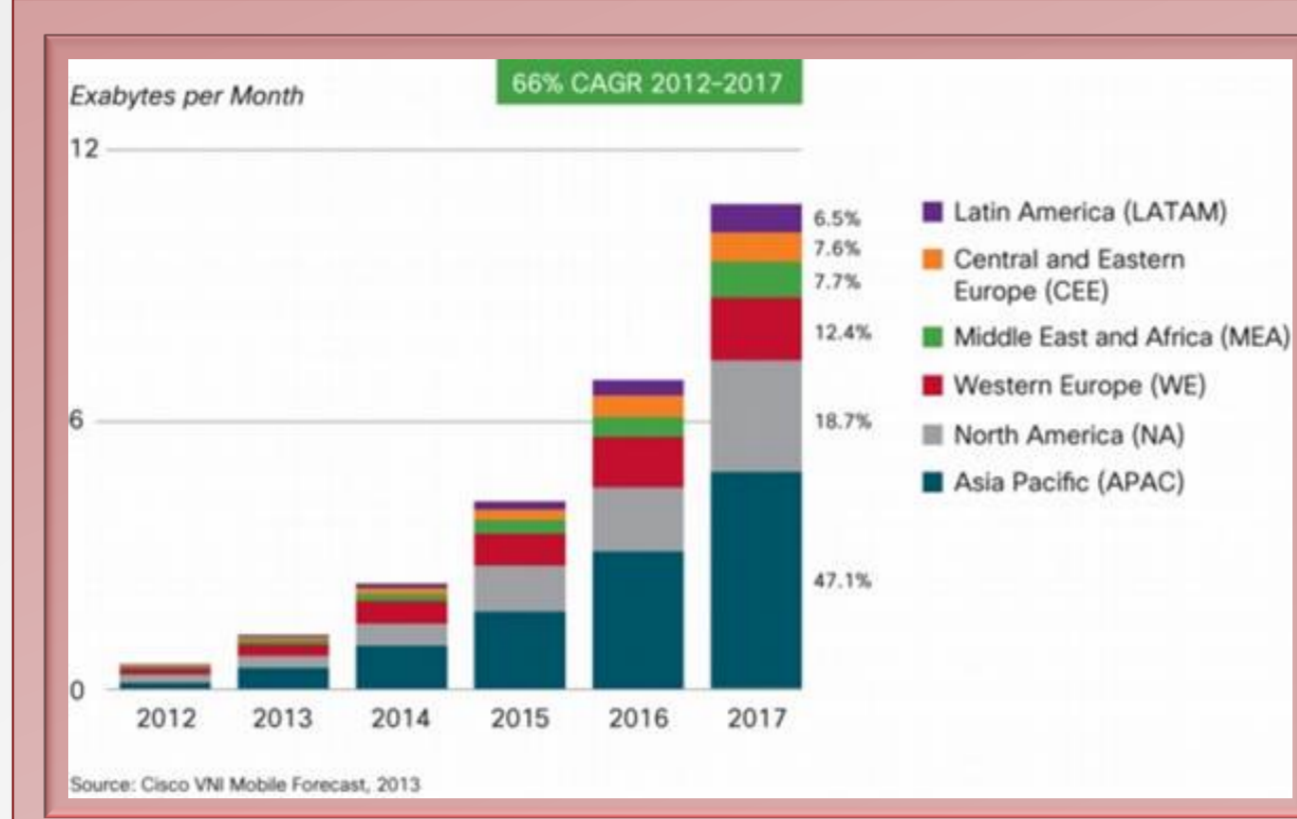

- Radio over Fiber (RoF) represents a hybrid concept
 - Fiber
 - high bandwidth and low losses
 - continuously increasing bandwidth
 - Wireless
 - flexibility and mobility
 - lower capacity
 - operation in higher frequencies

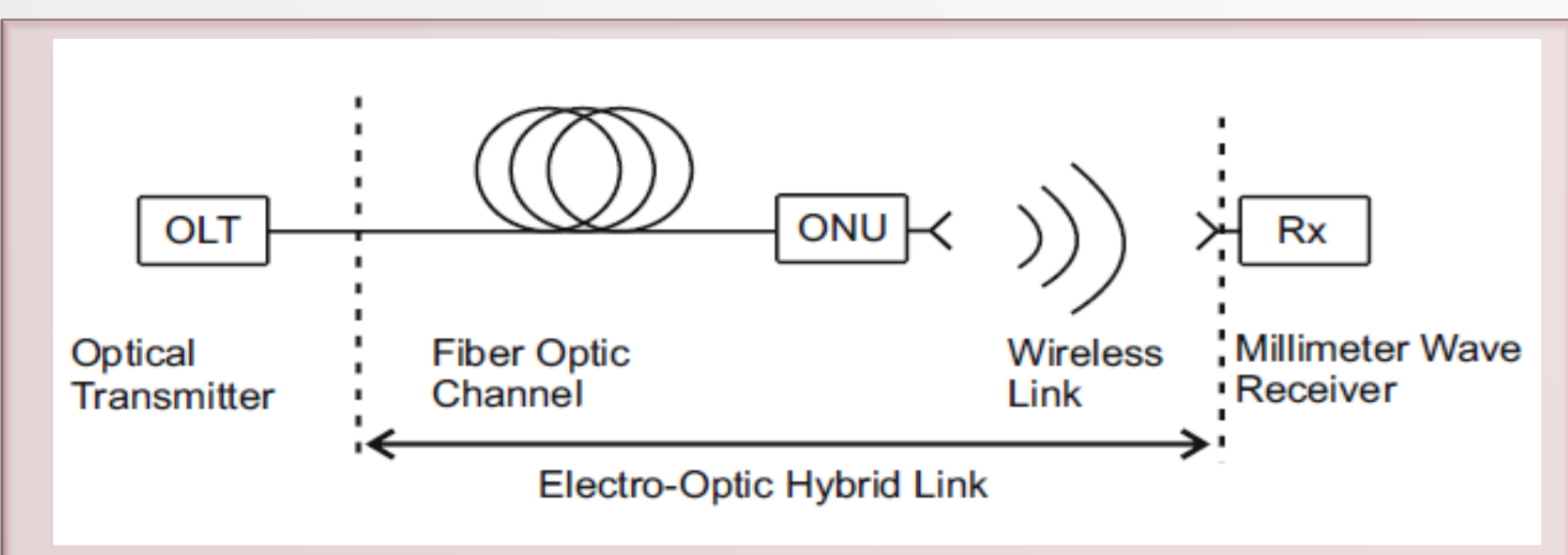

- Advantages of using RoF at W-Band
 - Bandwidth (in terms of bits/s) is not a problem
 - Already developed technology, from optical communications
 - Transport over long distances (or short if one wishes)
 - Generators do not need to be next to the antenna
 - Very good scalability
 - Splitting and amplifying not really a problem in optics (*somehow*)

- Current work
 - Channel model for hybrid composite fiber-wireless
 - Use of advanced modulation formats

How far can we go?

$$C = BW \cdot ld |1 + SNR|$$

$$SNR = P_T + G_T + G_R - L_{FS} - IL - (N_0 + 10 \log_{10} B + NF)$$

$$L_{FS} = 20 \log_{10} \frac{4\pi f d_0}{c} + 10n \log_{10} \frac{d}{d_0}$$

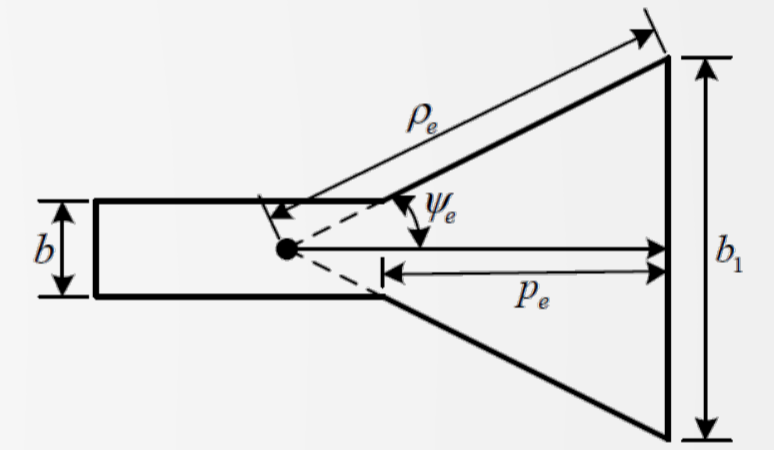
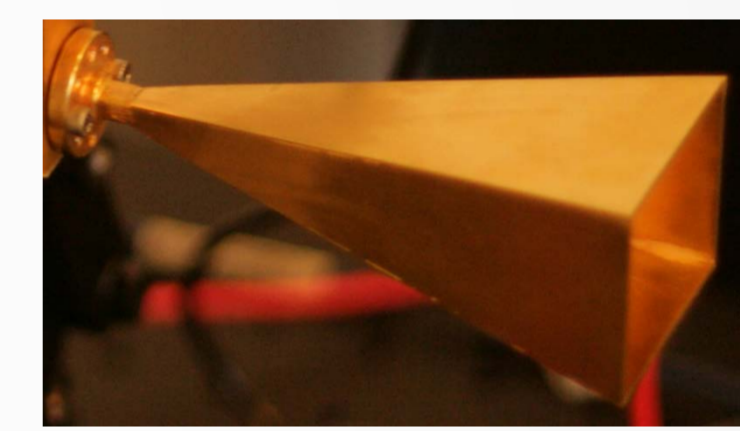

$$G(\phi, \theta) = G_0 \cdot e^{-\left(\frac{\phi, \phi_0}{\sigma_{g, \phi}}\right)^2} \cdot e^{-\left(\frac{\theta, \theta_0}{\sigma_{g, \theta}}\right)^2}$$

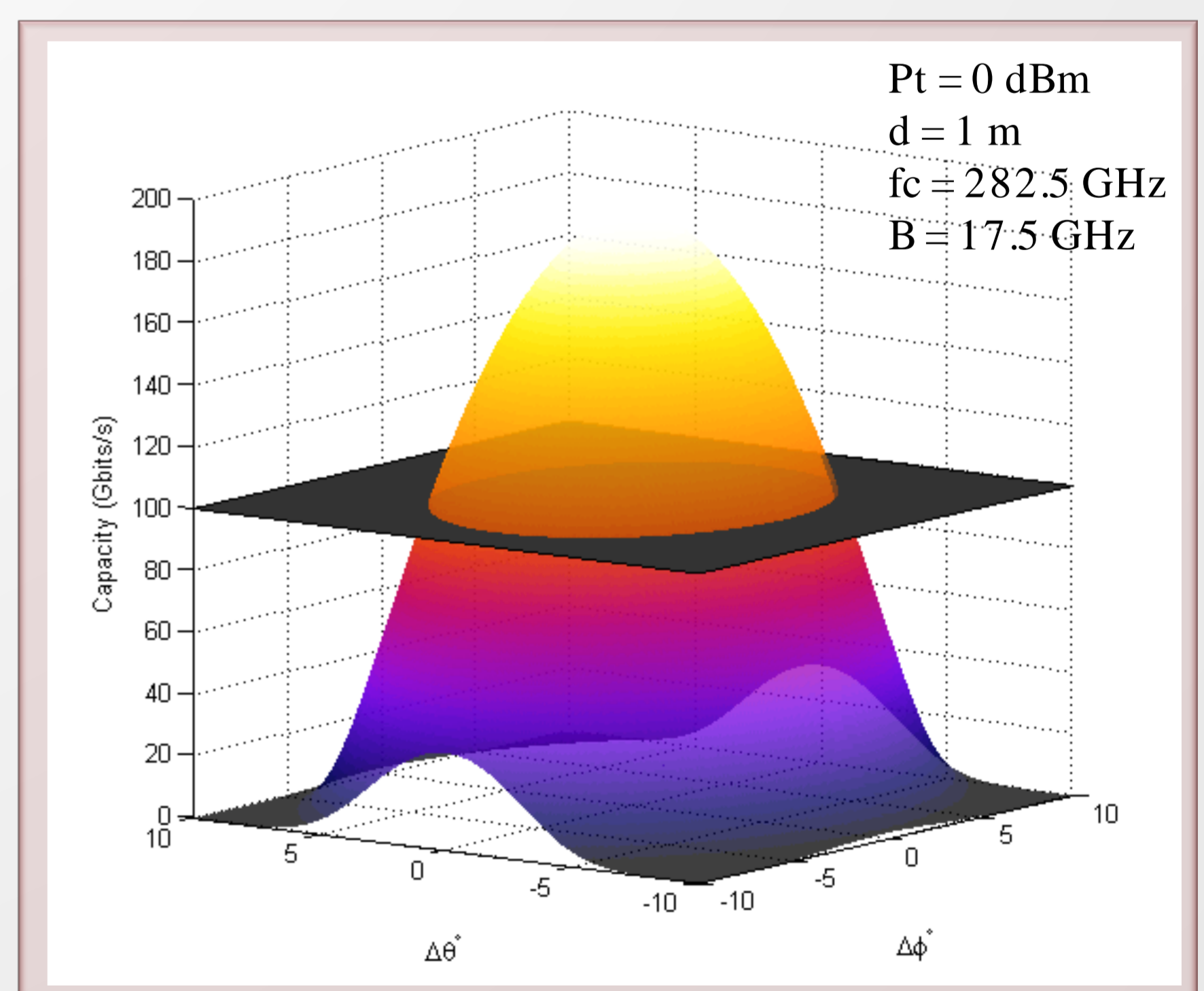
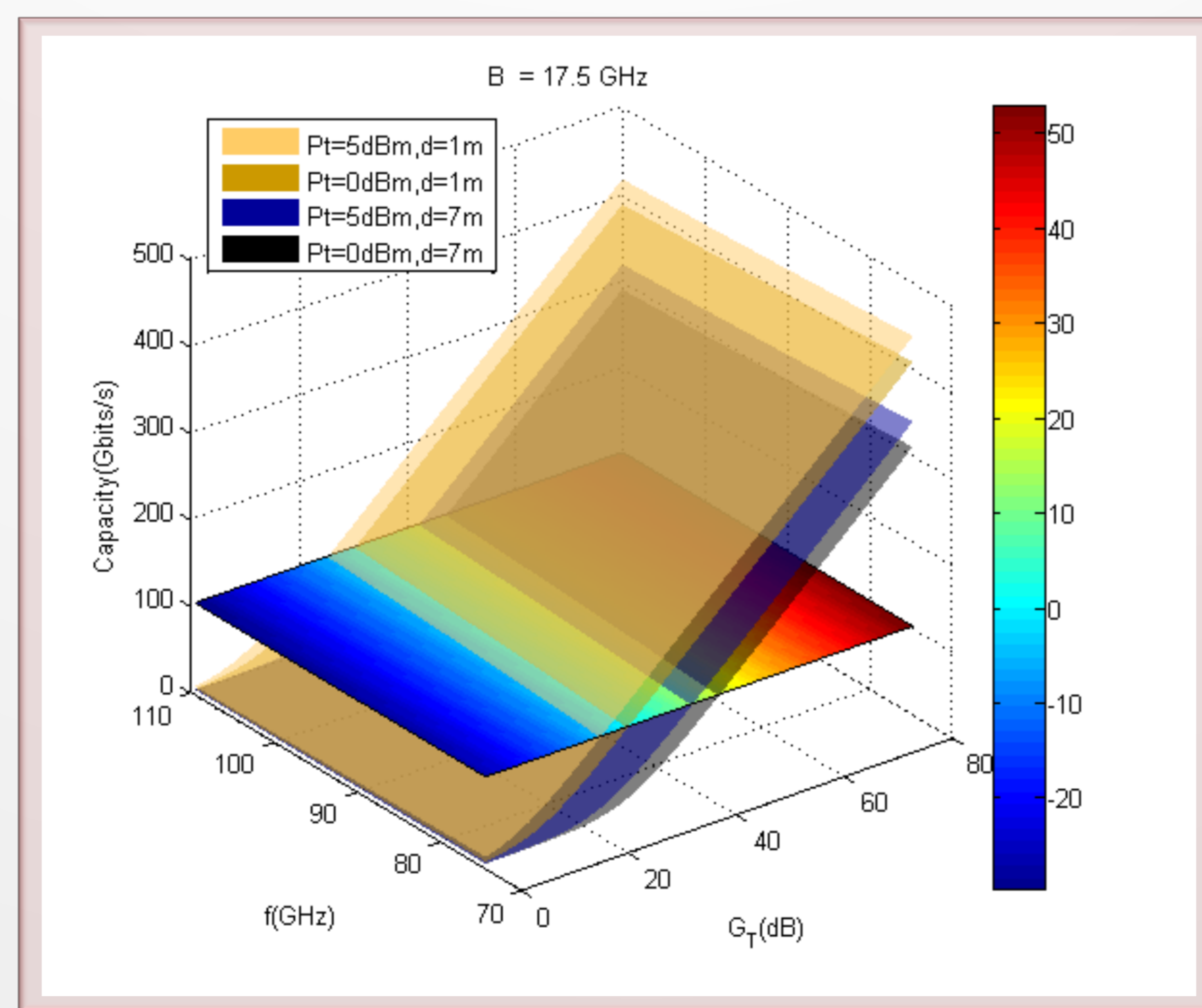
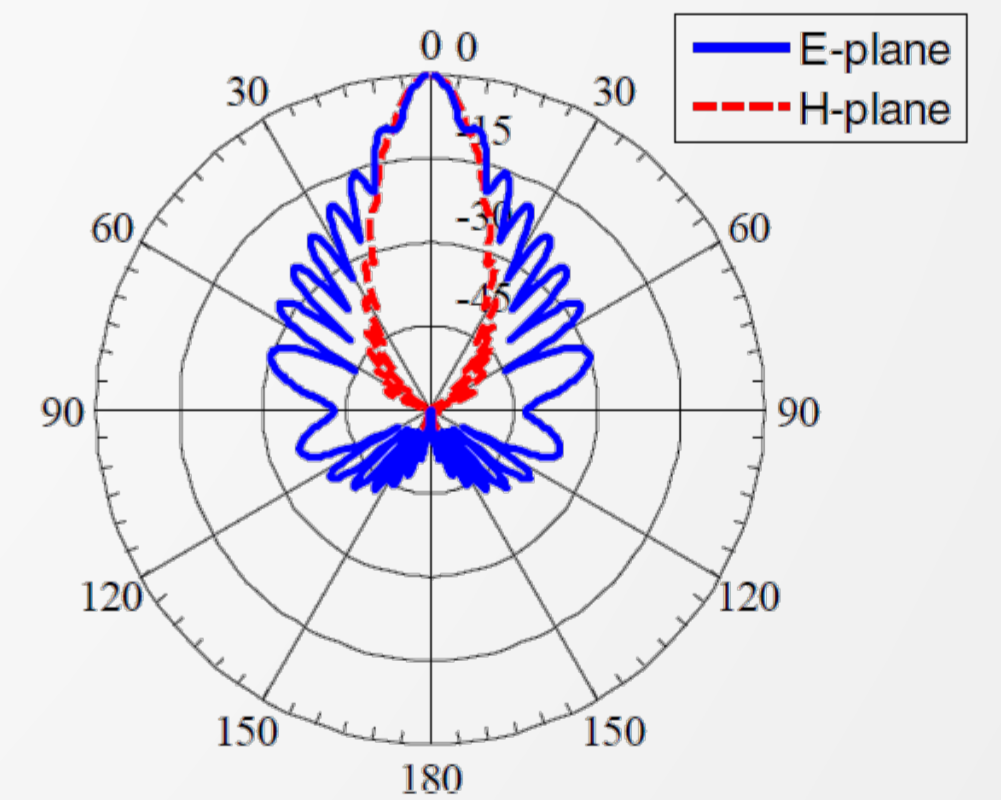

- Photonic technologies enable high capacity wireless links:
 - 100 Gbps wireless transmission
 - Transmission over different types of fibers
 - DSP techniques fairly mature
 - Bidirectional wireless-optical fibre bridge