



Optimization of the Process Parameters for Controlling Residual Stress and Distortion in Friction Stir Welding

Tutum, Cem Celal; Schmidt, Henrik Nikolaj Blicher; Hattel, Jesper Henri

Published in:

Optimization of the Process Parameters for Controlling Residual Stress and Distortion in Friction Stir Welding

Publication date:

2008

Document Version

Publisher's PDF, also known as Version of record

[Link back to DTU Orbit](#)

Citation (APA):

Tutum, C. C., Schmidt, H. N. B., & Hattel, J. H. (2008). Optimization of the Process Parameters for Controlling Residual Stress and Distortion in Friction Stir Welding. In Optimization of the Process Parameters for Controlling Residual Stress and Distortion in Friction Stir Welding Italy, Venice: TCN CAE 2008.

General rights

Copyright and moral rights for the publications made accessible in the public portal are retained by the authors and/or other copyright owners and it is a condition of accessing publications that users recognise and abide by the legal requirements associated with these rights.

- Users may download and print one copy of any publication from the public portal for the purpose of private study or research.
- You may not further distribute the material or use it for any profit-making activity or commercial gain
- You may freely distribute the URL identifying the publication in the public portal

If you believe that this document breaches copyright please contact us providing details, and we will remove access to the work immediately and investigate your claim.

Optimization of the Process Parameters for Controlling Residual Stress and Distortion in Friction Stir Welding

Cem C. Tutum*, **Henrik B. Schmidt**, **Jesper H. Hattel**

Technical University of Denmark, Department of Mechanical Engineering, Process Modeling Group,
2800 Kgs. Lyngby, Denmark

*Email: cctu@mek.dtu.dk

Summary

In the present paper, numerical optimization of the process parameters, i.e. tool rotation speed and traverse speed, aiming minimization of the two conflicting objectives, i.e. the residual stresses and welding time, subjected to process-specific thermal constraints in friction stir welding, is investigated. The welding process is simulated in 2-dimensions with a sequentially coupled transient thermo-mechanical model using ANSYS. The numerical optimization problem is implemented in modeFRONTIER and solved using the Multi-Objective Genetic Algorithm (MOGA-II). An engineering-wise evaluation or ranking between alternatives of the trade-off solutions is discussed briefly.

Keywords

Friction stir welding, residual stress, thermal constraints, multi-objective optimization

Introduction

Friction Stir Welding (FSW) is an efficient solid-state, i.e. without melting, joining technique that is invented especially for aluminum alloys which are difficult to weld with traditional welding techniques [1]. Improved mechanical properties, reduced distortion and residual stresses, and environment friendliness are some of its advantages. The requirement for lighter and load resistant structures, especially in aerospace and automotive industries, emphasizes the need for investigating the important parameters to control the FSW process more efficiently [2-4].

Heat dissipation due to the friction and material deformation causes the material to soften and allows traversing of the tool along the joint line. Despite relatively low heat generation in FSW, the rigid clamping used in FSW causes higher reaction forces on the plates avoiding the shrinkage of the weld center region and as a result, generating longitudinal and transverse stresses. These residual stresses act as pre-stresses on the structures which is critical for the fatigue performance during the service [2,4].

Thermo-Mechanical Model

The friction stir welding process is simulated in 2-dimensions by using ANSYS Parametric Design Language (APDL). Transient thermal and mechanical models are coupled sequentially (Figure 1,2). The thermo-pseudo-mechanical (TPM) heat source [5,6] is applied, in which the temperature dependent yield stress is the driver for the heat generation, as a volume flux given by

$$q(r, T) = \left(\frac{\text{RPM} \cdot 2\pi}{60} \right) \left(\frac{r}{\text{thk}} \right) \frac{\sigma_{\text{yield}}(T)}{\sqrt{3}}, \quad \text{for } 0 \leq r \leq R_{\text{shoulder}} \quad (1)$$

where RPM is the tool rotation per minute, r is the radial position, thk is the thickness of the plate (3mm) and R_{shoulder} is the tool shoulder radius (10mm). The temperature dependent yield stress σ_{yield} is defined by

$$\sigma_{\text{yield}}(T) = \sigma_{\text{yield,ref}} \left(1 - \frac{T - T_{\text{ref}}}{T_{\text{melt}} - T_{\text{ref}}} \right) \quad (2)$$

where $\sigma_{\text{yield,ref}}$ is the yield stress at the room temperature (200 MPa), T is the solution dependent temperature, T_{ref} is the reference room temperature (20°C) and T_{melt} is the solidus temperature (500°C). The mechanical model consists of an elasto-plastic material model using the yield stress given by equation (2). The behavior of the residual stresses obtained after the solution of the mechanical model is shown in Figure 3 for different tool traverse and rotational speeds. It can be clearly seen that the residual stresses increase as long as the traverse welding speed increases and they are less sensitive to the tool rotational speed.

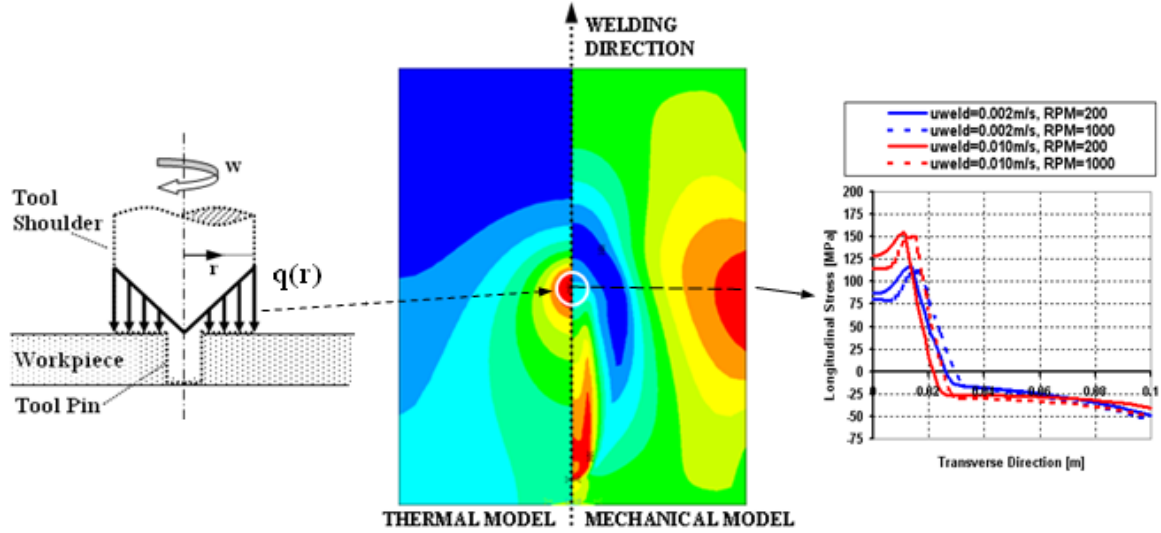

Figure 1. Schematic view of the prescribed heat source

Figure 2. Thermal and mechanical models

Figure 3. Residual stresses at the middle of the plate

Optimization Model

The optimization problem here is stated as the goal of finding the friction stir welding process parameters, i.e. tool rotation speed and traverse welding speed, which provide a set of trade-off solutions for the minimization of two conflicting objectives [7], i.e. residual stresses, which are measured at the middle of the plate along the transverse direction, and welding time. The design variable RPM (Revolution Per Minute) is defined as varying from 100 to 1000 rpm in 100 rpm increments and welding speed, the design variable for the traverse welding speed, is defined as 1mm/s to 10mm/s in 1 mm/s increments. The flow chart of the optimization procedure is shown in Figure 4. The initial population of the MOGA-II algorithm is chosen as Full Factorial Design with 4-levels (RPM: 100, 400, 700, 1000 rpm and welding speed: 1, 4, 7, 10mm/s) resulting in 16 designs. MOGA-Adaptive Evolution is chosen for running 20 total numbers of generations. The optimization problem is constrained by process-specific thermal constraints, which are given as the upper and the lower bounds on the peak temperatures. The lower bound of 420°C on the peak temperature represents the need for easy traversing of the tool, i.e. to minimize the tool loads, along the weld line by contributing thermal softening of the workpiece material. The upper bound of 490°C is defined in order to consider the tool life and the workpiece properties which are affected by hot weld conditions. The modeFRONTIER model is represented in Figure 5.

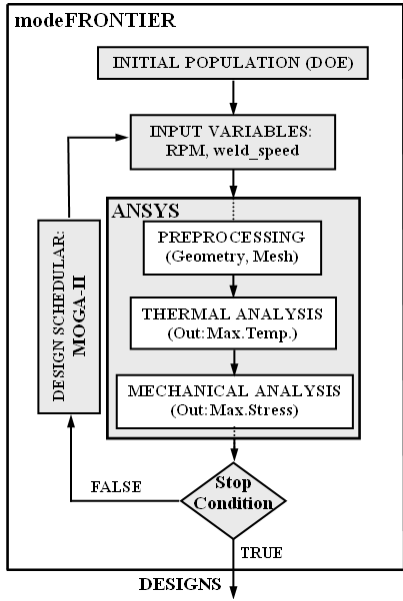

Figure 4. Flow chart of the optimization problem

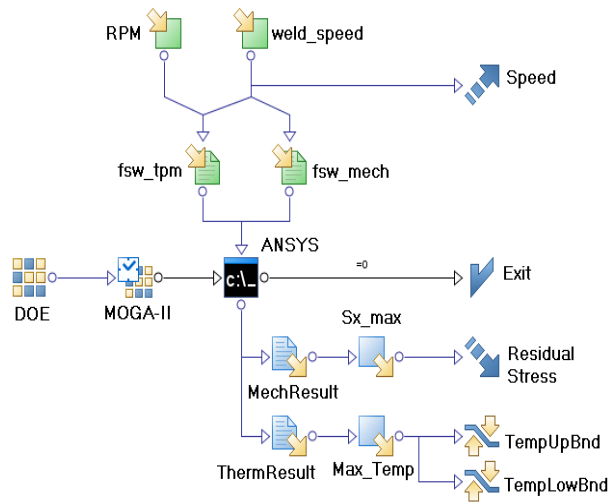

Figure 5. Workflow representation of modeFRONTIER model

Results and Discussion

The solution of the optimization problem, which is defined in the previous section, is presented in both design and criterion space in the following figures. Some of the designs out of 320 total numbers of designs are overlapping due to the selection operator which lies in the nature of the genetic algorithm and ensures the survival of some designs without evolution. Figure 6 and 7 represent feasible and unfeasible designs with dark and fair colors, respectively. It can be clearly seen from Figure 7 that the feasible region, which can be called as the robust process parameter region in this case, is defined by RPM values in the region between 200 and 400 rpms.

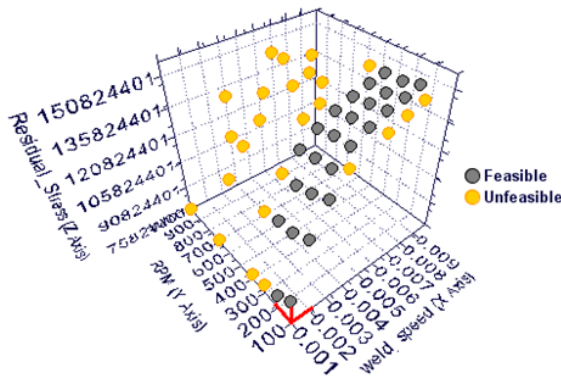

Figure 6. Residual stress vs. design variables

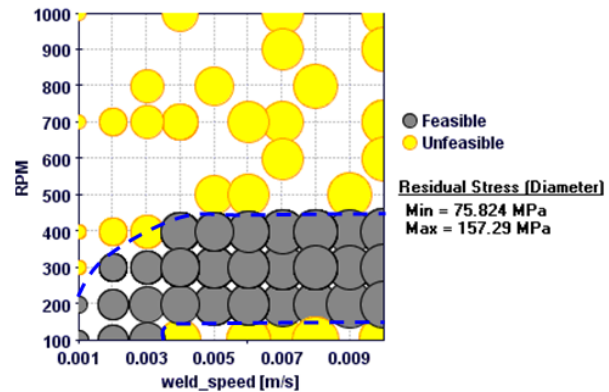

Figure 7. Contour plot of residual stress vs. inputs

The objective space that is constructed by minimization of the residual stresses and maximization of the welding speed is shown in Figure 8. Most of the designs lie close to the Pareto-front, which is shown in Figure 9, due to the low sensitivity of the RPM parameter defined in the underlying thermal model, i.e. the TPM model [5,6] for a given welding speed on the residual stresses.

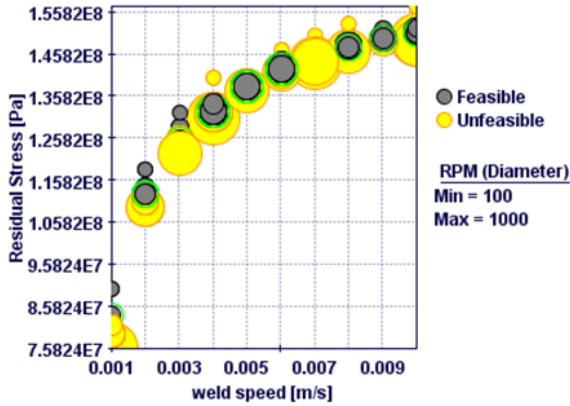

Figure 8. Objective Space of the solution

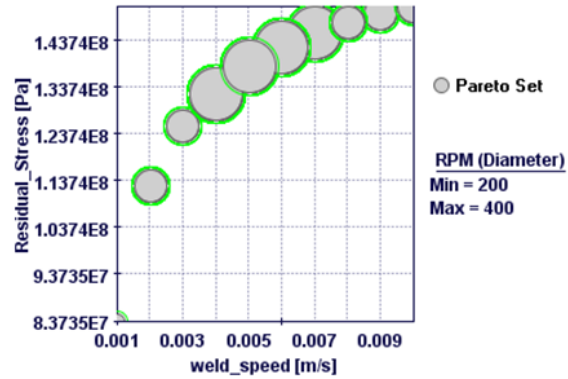

Figure 9. Pareto Set of the solution

The Pareto-front gives an idea of ranking the alternative trade-off designs depending on the available working conditions. If a manufacturer is able to use a standard milling machine instead of an advanced FSW machine and can afford using simple tool designs with low welding speed, he would probably not dare to go from 1 to 2mm/s or 2 to 3 mm/s welding speed because the residual stresses yielded per unit increment in welding speed would cost higher comparing to those at higher welding speeds. The amount of sacrifice of the manufacturer highly depends on the welding speed while one can keep the rotation speed between 200 and 400 rpms.

Conclusions

In conclusion, a multi-objective optimization application in the friction stir welding process has been presented. Minimization of the residual stresses and maximization of the welding speed have been considered simultaneously using the tool rotation speed and the traverse welding speed as the design variables. In addition to the description of the process goals, process-specific thermal limitations, i.e. lower and upper bounds on the peak temperature, have been added to the optimization problem in order to take the tool loads and tool life issues into account. At the end of the optimization study, feasible and unfeasible solutions are discussed and the Pareto solutions are presented. The results show that a tool rotation speed of 200 to 400 rpm can be considered as robust working conditions for almost all possible welding speeds. Depending on the Pareto designs, ranking of the trade-off solution alternatives has been discussed in addition to looking to the optimization problem from a manufacturer point of view.

Acknowledgements: Authors would like to thank David Richards from Manchester Materials Science Centre, Manchester University, UK, for valuable discussion on residual stresses in friction stir welding; Esteco Nordic, Sweden, for their continuous technical support on modeFRONTIER as well as EnginSoft, Italy, for their University Program and interest in our research activities.

References

- [1] Mishra, R.S., Ma, Z.Y.: "Friction stir welding and processing", Materials Science and Engineering R, Vol. 50, 2005, pp. 1-78
- [2] Richards, D.G., Pragnell, P.B., Williams, S.W., Withers, P.J.: "Global mechanical tensioning for the management of residual stresses in welds", Materials Science and Engineering A, Vol. 489, 2008, pp. 351-362
- [3] Tutum, C.C., Schmidt, H., Hattel, J., Bendsøe, M.: "Estimation of the Welding Speed and Heat Input in Friction Stir Welding using Thermal Models and Optimization", 7th World Congress on Structural and Multidisciplinary Optimization, Seoul, May 2007, pp. 2639-2646
- [4] Tutum, C.C., Schmidt H.B. Hattel, J.: "Assesment of Benchmark Cases for modeling of Residual stresses and Distortions in Friction Stir Welding", 7th International Symposium Friction Stir Welding, TWI, May 2008.
- [5] Schmidt, H., Hattel, J.: "Thermal modelling of friction stir welding", Scripta Materialia, 58, 2008, pp. 332-337
- [6] Schmidt, H.B., Hattel, J.H.: "A thermal-pseudu-mechanical model for the heat generatin in Friction Stir Welding" 7th International Symposium Friction Stir Welding, TWI, May 2008.
- [7] Deb, K.: "Multi-Objective Optimization Using Evolutionary Algorithms", John Wiley & Sons, 2001