



Robust Control Mixer Method for Reconfigurable Control Design Using Model Matching Strategy

Yang, Zhenyu; Blanke, Mogens; Verhagen, Michel

Published in:
IET Control Theory and Applications

Publication date:
2007

Document Version
Publisher's PDF, also known as Version of record

[Link back to DTU Orbit](#)

Citation (APA):
Yang, Z., Blanke, M., & Verhagen, M. (2007). Robust Control Mixer Method for Reconfigurable Control Design Using Model Matching Strategy. IET Control Theory and Applications, 1(1), 349-357.

DTU Library

Technical Information Center of Denmark

General rights

Copyright and moral rights for the publications made accessible in the public portal are retained by the authors and/or other copyright owners and it is a condition of accessing publications that users recognise and abide by the legal requirements associated with these rights.

- Users may download and print one copy of any publication from the public portal for the purpose of private study or research.
- You may not further distribute the material or use it for any profit-making activity or commercial gain
- You may freely distribute the URL identifying the publication in the public portal

If you believe that this document breaches copyright please contact us providing details, and we will remove access to the work immediately and investigate your claim.

Robust Control Mixer Method for Reconfigurable Control Design Using Model Matching Strategy

Zhenyu Yang^a Mogens Blanke^b Michel Verhaegen^c

^a*Department of Computer Science and Engineering, Aalborg University Esbjerg, Niels Bohrs Vej 8, DK-6700, Denmark. yang@cs.aau.dk*

^b*Section of Automation at Oersted-DATU, Elektrovej Build. 326, Technical University of Denmark, DK-2800 Kgs. Lyngby, Denmark. mb@oersted.dtu.dk*

^c*Delft Center for Systems and Control Engineering, Delft University of Technology, Mekelweg 2, 2628 CD Delft, The Netherlands. M.Verhaegen@dcsc.tudelft.nl*

Abstract

A novel control mixer method for reconfigurable control designs is developed. The proposed method extends the matrix-form of the conventional control mixer concept into a LTI dynamic system-form. The H_∞ control technique is employed for these dynamic module designs after an augmented control system is constructed through the model-matching strategy. The stability, performance and robustness of the reconfigured system can be guaranteed when some conditions are satisfied. To illustrate the effectiveness of the proposed method, a robot system subjected to failures is used to demonstrate the reconfiguration procedure.

Key words: Reconfigurable control, control mixer, model matching, H_∞ control

1 Introduction

As a typical strategy for fault accommodation in the fault tolerance field [1,13], the control mixer method proposed in [8,12,14] has been popularly used in design of fault tolerant flight-by-wire flight control systems [2,7,11]. The main idea of this method is to preserve the nominal controller still under operation when some fault happens inside the considered system. Alternatively, a gain matrix, referred to as the *control mixer module*¹, will be inserted/modified into the impaired closed-loop system, such that this module redistributes signals inside the closed-loop system so

¹ Sometimes it is referred to as the *Control Distributor* [7,11,13].

as to preserve some system function to an extent. The control mixer method yields an efficient and economic way to improve an ordinary control system into a fault tolerant one, especially when the on-line reconstruction of nominal control law is difficult, or the nominal control component has already been implemented (e.g., by hardware) and integrated with the controlled system.

The Pseudo-Inverse technique was employed for the control mixer matrix design [2,8,11,12,14]. However, this kind of synthesis lacks many important features, such as

- It can't guarantee the stability of the reconfigured closed-loop system. The *Modified Pseudo-Inverse Method (MPIM)* proposed in [5] could be used for a stable design, but MPIM has too conservative restrictions and loses the optimal sense for dealing with MIMO systems [5,6];
- The performance of the reconfigured system can not be evaluated from this design when there is no perfect reconfiguration [6,15];
- It lacks of robustness with respect to the fact that the nominal and impaired system information is assumed to be known precisely [17];
- It is only suitable for dealing with actuator failures [8,12,14] .

To overcome above drawbacks, a novel approach called the *Robust Control Mixer (RCM)* method is proposed in this paper. Within the RCM method, the control mixer is designed as a LTI system-form instead of the conventional matrix-form, and multiple modules can be employed for fault accommodation instead of using single module. The objective of RCM is to make the closed-loop transfer matrix of the reconfigured system match that of the nominal system in the H_∞ -norm sense. Therefore, the H_∞ control [3,18] is employed for design of these dynamic modules after combining the nominal and impaired closed-loop systems into an augmented system via the model-matching strategy [3,6]. Regarding the performance recovery as well as the Input/Output (I/O) function recovery, a multiple objective RCM method is further discussed under the proposed framework. At last, demonstrations on a space robot system shows the potential of the proposed method in practical application.

The paper is organized as follows: Section 2 formulates the RCM problem; Section 3 discusses the RCM synthesis using the H_∞ control theory; Section 4 explores the multiple objective RCM problem and synthesis; Section 5 tests the proposed method on a space robot system; Finally, Section 6 is discussions and conclusions.

2 Problem Formulation

In the following, we restrict our discussion to a class of continuous-time LTI control systems with input and output disturbances and possible abrupt parametric

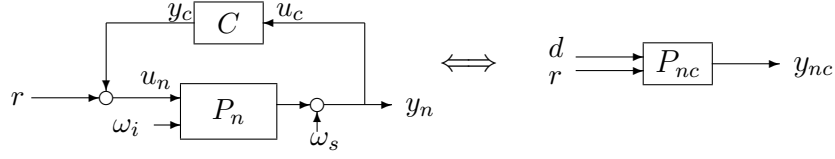

Fig. 1. The Considered LTI Control System

faults². Consider a nominal control system as shown in Fig.1, where P_n , representing all components in the forward loop, is referred to as the *nominal plant*, and C , representing all components in the feedback loop, is referred to as the *nominal feedback controller*. In more detailed expression, there is

$$P_n : \begin{cases} \dot{x}_n(t) = A_n x_n(t) + B_n u_n(t) + E_n d(t) \\ y_n(t) = C_n x_n(t) + D_n u_n(t) + G_n d(t), \end{cases} \quad (1)$$

$$C : \begin{cases} \dot{x}_c(t) = A_c x_c(t) + B_c u_c(t) \\ y_c(t) = C_c x_c(t) + D_c u_c(t). \end{cases} \quad (2)$$

where $x_n \in R^{n_p}$ ($x_c \in R^{n_c}$) denotes the plant (controller) state, $u_n \in R^{m_p}$ ($u_c \in R^{m_c}$) denotes the plant (controller) input, $y_n \in R^{r_p}$ ($y_c \in R^{r_c}$) denotes the plant (controller) output. Vector $d \hat{=} [\omega_i^T \ \omega_s^T]^T \in R^{n_d}$ ($n_d = n_i + n_s$) denotes the stack of plant external disturbances, which include the input noise $\omega_i \in R^{n_i}$, and measurement noise $\omega_s \in R^{n_s}$. Assume there already is³ $\|d\|_2 \leq 1$. Within Fig.1, r represents the reference signal into the considered system and there is $\|r\|_2 \leq 1$. Assume the nominal closed-loop control system is well-posed and can be described in a compact form P_{nc} as shown in Fig.1, with system matrices $A_{nc}, B_{nc}, C_{nc}, D_{nc}, E_{nc}$ and G_{nc} , respectively.

When some abrupt fault happens insider the considered closed-loop system, without triviality, we assume the considered fault locates inside the plant. Then, the *impaired plant*, denoted as P_f , can be described as:

$$P_f : \begin{cases} \dot{x}_f(t) = A_f x_f(t) + B_f u_n(t) + E_n d(t) \\ y_f(t) = C_f x_f(t) + D_f u_n(t) + G_n d(t). \end{cases} \quad (3)$$

where A_f, B_f, C_f and D_f in (3) represent the impaired system matrices and they are assumed to be able to be provided by FDI algorithms. We further assume the

² The extension to deal with additive faults and FDI uncertainties as well as non-linearity can be found in [17].

³ For the general case, a proper weighting function should be selected so as to make this assumption satisfied.

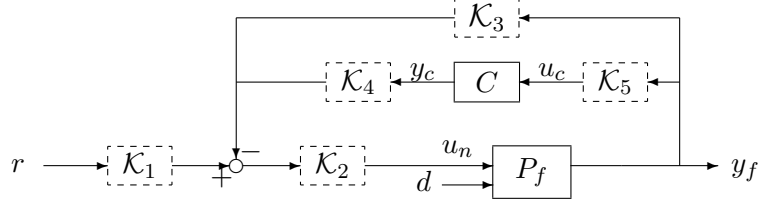

Fig. 2. Possible Control Mixer Modules in Considered Configuration

impaired closed-loop system is well-posed and can be described by a compact form P_{fc} with matrices $A_{fc}, B_{fc}, C_{fc}, D_{fc}, E_{fc}$ and G_{fc} , respectively.

Once some connections within the considered system configuration can be split and some extra modules can be inserted into these open locations, or some already existing components can be separated from the plant and/or controller such that they can be redesigned (these phenomena can be understood in practical situations as that some extra equipment can be added into the already existing system, or some (hardware or software) components inside the system can be modified or redesigned), no matter which cases, we refer to these modules/components as *control mixer modules* in a generalized sense. For example, one possible reconfiguration corresponding to Fig.1 is shown in Fig.2, where dash-boxes denote the possible locations for control mixer modules.

Let \mathcal{K}_i represent the transfer matrix of the i th control mixer as shown in Fig.2, \mathcal{P}_{nc} represent the transfer matrix of the nominal closed-loop system from $[d^T \ r^T]^T$ to y_n , and $\mathcal{P}_{fc}(\mathcal{K}_1, \dots, \mathcal{K}_l)$ represent the transfer matrix of the reconfigured closed-loop system from $[d^T \ r^T]^T$ to y_f using module $\mathcal{K}_1, \dots, \mathcal{K}_l$ for reconfiguration. Then, the RCM problem can be defined as:

Find a minimum-element set of non-identity (or different with previous values) compensating modules from a permitted set with N elements, denoted as $\{\mathcal{K}_i\}_{i=1}^{l^}$, where \mathcal{K}_i are real-rational and proper for $i = 1, \dots, l^*$, denoted as $\mathcal{K}_i \in \mathcal{R}_{ss}$, such that*

$$l^* = \arg \min_{l \leq N} \left(\min_{\mathcal{K}_i \in \mathcal{R}_{ss}, i = 1, \dots, l} \|\mathcal{W}(\mathcal{P}_{nc} - \mathcal{P}_{fc}(\mathcal{K}_1, \dots, \mathcal{K}_l))\|_{\infty} \right) \quad (4)$$

under the condition that the reconfigured system is internally stable. Here N represents the number of possible control mixer modules (such as in Fig.2 the N is 5) and \mathcal{W} is a weighting function matrix.

From (4) it can be observed that the RCM problem consists of two cooperative parts, i.e., the acquisition of the optimal value l^* ; and synthesis of each used control mixer module. Hereby the RCM synthesis problem not only relates to the concrete forms of the nominal and impaired systems, but also relates to the whole system's network structure. In the following, we consider the individual module design using the H_{∞} control theory and let the multiple module design problem as the future work.

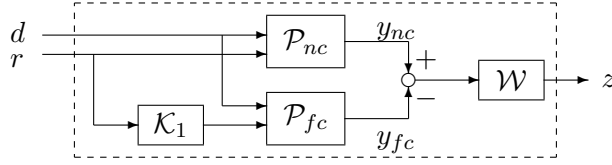

Fig. 3. Problem Formulation for Designing Module \mathcal{K}_1

3 RCM Module Synthesis

It can be seen that the RCM problem (4) fits into the model-matching/following framework well [3,6,7]. In the following the synthesis of \mathcal{K}_1 and \mathcal{K}_4 is discussed respectively. For the other cases, this proposed approach can be extended straightforwardly. Before we discuss the module synthesis, the solvability of the proposed problem should be explored with respect to the real-time constraint for the on-line control reconfiguration. Here the two-Riccati-equation method [18] is used for the state space analysis and Francis' theory [3] for the frequency-domain analysis.

3.1 Solvability of Using Module \mathcal{K}_1

Regarding the location of \mathcal{K}_1 as shown in Fig.2, there is $\mathcal{P}_{fc}(\mathcal{K}_1) = [\mathcal{P}_{fc}^d \quad \mathcal{P}_{fc}^r \mathcal{K}_1]$, where \mathcal{P}_{fc}^d (\mathcal{P}_{fc}^r) represents the transfer matrix of the impaired closed-loop system from d (r) to y_{fc} . Therefore, the problem (4) of using \mathcal{K}_1 is simplified to solve

$$\min_{\mathcal{K}_1 \in \mathcal{R}_{ss}} \|\mathcal{W}(\mathcal{P}_{nc} - \mathcal{P}_{fc}(\mathcal{K}_1))\|_{\infty}, \quad (5)$$

under the condition that $\mathcal{P}_{fc}(\mathcal{K}_1)$ is stable.

It can be noticed that problem (5) is a model-matching problem as stated in [3]. An augmented control system can be constructed as shown in Fig.3. Under the assumption that \mathcal{P}_{nc} is stable and detectable, we have:

Lemma 1: The solution for synthesis problem (5) exists if the impaired closed-loop system is stable, i.e., $\mathcal{P}_{fc}^d, \mathcal{P}_{fc}^r \in \mathcal{RH}_{\infty}$.

With respect to the situation that sometimes the fault information provided by the FDI algorithm may be in the state space form, it is also worthwhile to explore the solvability of problem (5) in the state space form. Assume the weighting matrix

\mathcal{W} has a LTI realization and which is denoted as⁴ $\left[\begin{array}{c|c} A_w & B_w \\ \hline C_w & D_w \end{array} \right]$. The system configuration as shown in Fig.3 can be redrawn equally as shown in Fig.4. Under

⁴ When \mathcal{W} needs to be selected non-properly, we can move some terms of \mathcal{W} into the plant model, such that both of them are proper function matrices.

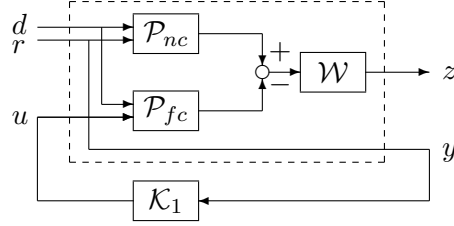

Fig. 4. The Augmented Control System Using \mathcal{K}_1

the assumption that \mathcal{P}_{nc} is stable, detectable and has no poles on the imaginary axis, we have:

Theorem 2: The solution for synthesis problem (5) exists if

- A_{fc} and A_w are stable matrices, $D_w D_{fc}$ is full column rank; and

- $$\begin{bmatrix} j\lambda I - A_{fc} & 0 & B_{fc} \\ B_w C_{fc} & j\lambda I - A_w & -B_w D_{fc} \\ D_w C_{fc} & C_w & -D_w D_{fc} \end{bmatrix}$$
 is full column rank for all $0 \leq \lambda \leq \infty$; and
- $$\begin{bmatrix} j\lambda I - A_{nc} & 0 & 0 & E_{nc} \\ 0 & j\lambda I - A_{fc} & 0 & E_{fc} \\ -B_w C_{nc} & B_w C_{fc} & j\lambda I - A_w & B_w (G_{nc} - G_{fc}) \end{bmatrix}$$
 is full row rank for all $0 \leq \lambda \leq \infty$.

Proof: See the Appendix A.

It can be observed that \mathcal{K}_1 acts as a forward compensator. There is no feedback mechanism in this compensating configuration. Specially, when the disturbance signal $d(t)$ can be neglected, i.e., $E_{nc} = E_{fc} = G_{nc} = G_{fc} = 0$, the conditions in lemma 2 simplifies to

Corollary 3: Synthesis problem (5) can be solvable if

- Matrices A_{fc} and A_w are stable matrices and
- $D_w D_{fc}$ is full column rank.

3.2 Solvability of Using Module \mathcal{K}_4

When \mathcal{K}_4 is employed for reconfiguration, the synthesis problem (4) can be reduced to solve the optimal problem

$$\min_{\mathcal{K}_4 \in \mathcal{R}_{ss}} \|\mathcal{W}(\mathcal{P}_{nc} - \mathcal{P}_{fc}(\mathcal{K}_4))\|_{\infty}, \quad (6)$$

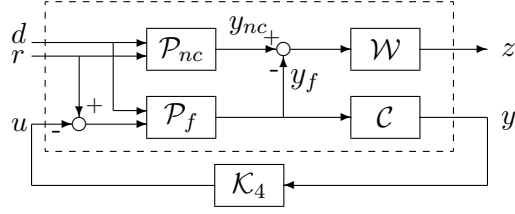

Fig. 5. The Augmented Control System Using \mathcal{K}_4

under the condition that the reconfigured closed-loop system $\mathcal{P}_{fc}(\mathcal{K}_4)$ is internally stable. Similar to the case of \mathcal{K}_1 design, an augmented system can also be constructed via model-matching as shown in Fig.5. With respect to the linear system theory [3], we have:

Theorem 4: The solution for synthesis problem (6) exists if $\mathcal{C}\mathcal{P}_{fu}$ is stabilizable and $[\overline{M}_2\mathcal{C}\mathcal{P}_{fd} \quad -\overline{N}_2]$ has no zeros and poles on the imaginary axis, where $M_2, N_2, \overline{M}_2, \overline{N}_2$ are the components of doubly-coprime factorization of $\mathcal{C}\mathcal{P}_{fu}$, i.e.,

$$\mathcal{C}\mathcal{P}_{fu} = N_2M_2^{-1} = \overline{M}_2^{-1}\overline{N}_2, \text{ and } \begin{bmatrix} \overline{X}_2 & -\overline{Y}_2 \\ -\overline{N}_2 & \overline{M}_2 \end{bmatrix} \begin{bmatrix} M_2 & Y_2 \\ N_2 & X_2 \end{bmatrix} = I, \quad (7)$$

and \mathcal{P}_{fu} (\mathcal{P}_{fd}) represents the transfer matrix of the impaired plant P_f from u (d) to y_f , \mathcal{C} represents the transfer matrix of the nominal controller (2) from u_c to y_c .

Proof: See the appendix B.

The solvability of \mathcal{K}_4 synthesis problem can also be explored in the state space domain. One sufficient condition for problem (6) can be obtained in the following under the assumption that \mathcal{P}_{nc} is stable and has no poles on the imaginary axis:

Lemma 5: Synthesis problem (6) can be solvable if

- A_w is stable, $\left(\begin{bmatrix} A_f & 0 \\ B_c C_f & A_c \end{bmatrix}, [D_c C_f \quad C_c] \right)$ is detectable and $\left(\begin{bmatrix} A_f & 0 & 0 \\ B_c C_f & A_c & 0 \\ -B_w C_f & 0 & A_w \end{bmatrix}, \begin{bmatrix} -B_f \\ -B_c D_f \\ B_w D_f \end{bmatrix} \right)$ is stabilizable;
- $D_w D_f$ is full column rank and $[D_c D_f \quad D_c G_f]$ is full row rank;
- $\begin{bmatrix} j\lambda I - A_f & 0 & 0 & -B_f \\ -B_c C_f & j\lambda I - A_c & 0 & -B_c D_f \\ B_w C_f & 0 & j\lambda I - A_w & B_w D_f \\ -D_w C_f & 0 & C_w & D_w D_f \end{bmatrix}$ is full column rank and

$$\begin{bmatrix} j\lambda I - A_f & 0 & 0 & B_f & E_f \\ -B_c C_f & j\lambda I - A_c & 0 & B_c D_f & B_c G_f \\ B_w C_f & 0 & j\lambda I - A_w & B_w(D_{nc} - D_f) & B_w(G_{nc} - G_f) \\ D_c C_f & C_c & 0 & D_c D_f & D_c G_f \end{bmatrix} \text{ is full row rank}$$

for $0 \geq \lambda \geq \infty$.

The module \mathcal{K}_4 acts as a feedback compensator in the reconfigured system. When A_c and A_w both are stable, the conditions in lemma 5 can be simplified into

Corollary 6: Synthesis problem (6) can be solvable if

- $(A_f, D_c C_f)$ is detectable and (A_f, B_f) is stabilizable;
- $D_w D_f$ is full column rank and $[D_c D_f \ D_c G_f]$ is full row rank; and
- $\begin{bmatrix} j\lambda I - A_f & -B_f \\ -D_w C_f & D_w D_f \end{bmatrix}$ is full column rank, and $\begin{bmatrix} j\lambda I - A_f & B_f & E_f \\ D_c C_f & D_c D_f & D_c G_f \end{bmatrix}$ is full row rank for $0 \geq \lambda \geq \infty$.

3.3 Numerical Module Synthesis

The optimal problems (5) and (6) are solvable does not mean that the solution can always be found by some numerical algorithms. From the computational point of view, the γ -suboptimal problem corresponding to (5) or (6) is more reasonable in practical implementation [18]. Therefore, a general sub-optimal RCM problem corresponding to (4) can be proposed as:

Given a real positive scalar constant γ , find a minimum-element set of compensating modules needed to be designed, denoted as $\{\mathcal{K}_i\}_{i=1}^{l^}$, such that*

$$\|\mathcal{W}(\mathcal{P}_{nc} - \mathcal{P}_{fc}(\mathcal{K}_1, \dots, \mathcal{K}_{l^*}))\|_\infty < \gamma, \quad (8)$$

under the condition that the reconfigured system $\mathcal{P}_{fc}(\mathcal{K}_1, \dots, \mathcal{K}_{l^})$ is internally stable. Here l^* represents the minimum number of used RCMs such that (8) is satisfied.*

There are many numerical methods to deal with the γ -suboptimal problem, such as the two-Riccati-equation method [18] and LMI based method [4]. In order to get the numerical solution, besides the conditions mentioned in above subsection should be guaranteed, some extra conditions related to the adopting numerical algorithms should also be satisfied. One interesting thing using γ -iteration is that the γ can be regarded as a kind of quantitative evaluation of the control reconfiguration. The infimum γ^* represents the best reconfiguration level that a LTI controller can achieve with respect to the provided impaired System [17].

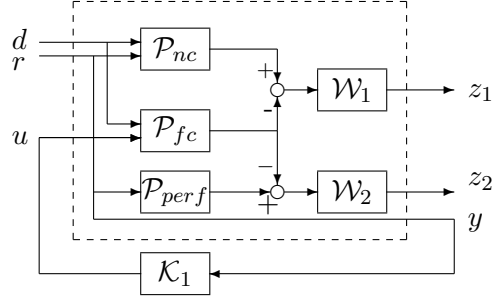

Fig. 6. The Augmented Control System for MORCM Problem Using \mathcal{K}_1

Corollary 7: Given a real scalar constant $\gamma > 0$, if there exists a real rational controller \mathcal{K}_i (e.g., $i = 1$ or 4), which satisfies (8), then the tracking error between the nominal and reconfigured systems is bounded by

$$\|y_{nc} - y_{fc}(\mathcal{K}_i)\|_2 < \gamma\beta, \quad (9)$$

where β is the excitation level of the system, i.e., $\|[d^T \ r^T]^T\|_2 = \beta$.

4 Multiple Objective RCM Synthesis

The RCM synthesis can be regarded as a kind of I/O function recovery [1,15]. However, if the reconfigured system achieved through this method can not match the nominal system (almost) exactly, and the nominal system was not designed 'nicely', this design has a large risk to lead the reconfigured system into a degraded or even worse performance, such as the reconfigured system might lose the signal tracking ability when it is synthesized with a large γ value through the γ -iteration. In order to consider the desired performance as well as the I/O function recovery, a multiple objective RCM method is further proposed in [16].

Assume the desired performance for the nominal system is known and can be described by a $\bar{r}_p \times m_p$ matrix, denoted as $\mathcal{P}_{perf}(s)$, which denotes the transfer matrix from $r(t)$ (with dimension m_p) to some interested outputs, denoted as $y_{nc}^{perf}(t)$ with dimension \bar{r}_p , where $\bar{r}_p \leq r_p$. Usually there is $\mathcal{P}_{perf} \in \mathcal{RH}_\infty$. From the performance oriented point of view, a RCM synthesis problem can be proposed as: to solve the optimal problem

$$\min_{\mathcal{K} \in \mathcal{R}_{ss}} \|\mathcal{W}_p(\mathcal{P}_{perf} - \mathcal{P}_{fc}^{perf}(\mathcal{K}))\|_\infty \quad (10)$$

under the condition that $\mathcal{P}_{fc}^{perf}(\mathcal{K})$ is internally stable, where $\mathcal{P}_{fc}^{perf}(\mathcal{K})$ represents the transfer matrix of the reconfigured closed-loop system from $r(t)$ to $y_{fc}^{perf}(t)$.

Once we combine (4) and (10) together, a new model-matching problem, which

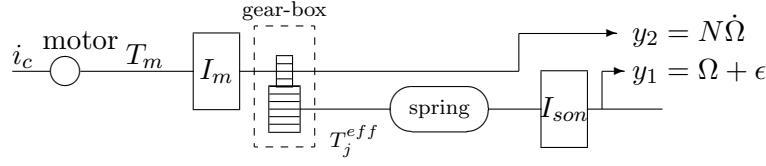

Fig. 7. The Basic Structure of the Space Robot System

is referred to as *Multiple Objective Robust Control Mixer (MORCM)* problem⁵, is proposed as [16]:

To synthesize a control mixer \mathcal{K} , such that the optimization problem

$$\min_{\mathcal{K}} \left\| \mathcal{W}_M \begin{pmatrix} \mathcal{P}_{nc} - \mathcal{P}_{fc}(\mathcal{K}) \\ \overline{\mathcal{P}}_{perf} - \overline{\mathcal{P}}_{fc}^{perf}(\mathcal{K}) \end{pmatrix} \right\|_{\infty} \quad (11)$$

can be solved under the condition that $\mathcal{P}_{fc}(\mathcal{K})$ is internally stable, where \mathcal{W}_M is a weighting matrix, $\overline{\mathcal{P}}_{perf} \triangleq [0_{\bar{r}_p \times n_d} \quad \mathcal{P}_{perf}]$ and $\overline{\mathcal{P}}_{fc}^{perf}(\mathcal{K}) \triangleq [0_{\bar{r}_p \times n_d} \quad \mathcal{P}_{fc}^{perf}(\mathcal{K})]$.

Comparing with problem (5) or (6) discussed in last section, here the MORCM problem (11) balances the I/O function recovery and the performance recovery through the selection of \mathcal{W}_M . The techniques used for the RCM synthesis can still be used to deal with the MORCM problem (11). Within the MORCM synthesis, besides

the channel $z_1 \triangleq \mathcal{W}(\mathcal{P}_{nc} - \mathcal{P}_{fc}(\mathcal{K})) \begin{bmatrix} d \\ r \end{bmatrix}$, an extra channel $z_2 \triangleq \mathcal{W}_p(\overline{\mathcal{P}}_{perf} - \overline{\mathcal{P}}_{fc}^{perf}(\mathcal{K}))r$

needs to be defined inside the augmented system constructed via model-matching. For example, the MORCM \mathcal{K}_1 synthesis is based on the augmented system as shown in Fig.6. More details about MORCM can be found in [16].

5 Benchmark Study

The linear model of a space robot system discussed in [10] is used to test the proposed RCM method. The scheme of the considered system is shown in Fig.7 and system parameters can be found in Table.1. A LQG controller has been developed in [15] for this robot system to deal with the signal tracking problem as shown in Fig.8. The whole closed-loop system is modelled as a two-input two-output eight-dimensional LTI system, where the plant state is $x_p \triangleq [\Omega \quad \dot{\Omega} \quad \epsilon \quad \dot{\epsilon}]^T$ and the plant output is $y_p \triangleq [\Omega + \epsilon \quad N\dot{\Omega}]^T$.

⁵ Here only the single module case is considered.

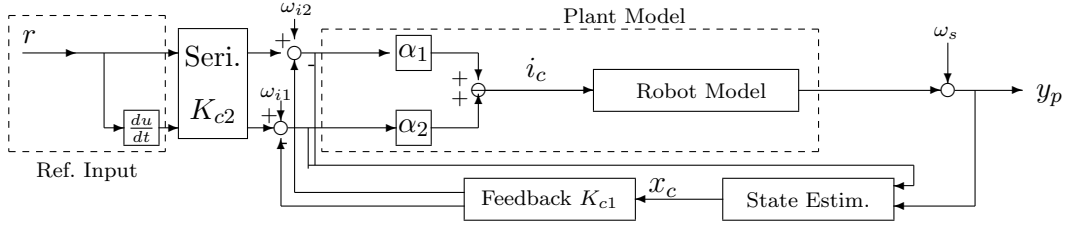

Fig. 8. The Closed-Loop Model of the Robot with a LQG Controller

Symbol	Description	Unit
$N = -260.6$	gear-box ratio	—
$I_m = 0.0011$	inertia of the input axis	kg m ²
Ω	joint angle of the internal axis	rad
$I_{son} = 400$	inertia of the output axis	kg m ²
T_j^{eff}	torque of effective joint input	Nm
ϵ	joint angle of output axis	rad
$K_t = 0.6$	motor torque constant	N/%
i_c	motor current	Am
$\beta = 0.4$	the damping coefficient	N/%
$c = 130000$	spring constant	N/%
T_{def}	deformation torque of gear-box	Nm
T_m	motor torque	Nm

Table 1 System Parameters of the Space Robot System

In following simulation tests, two kinds of fault situations are considered: an actuator fault and a multiple system fault; both fault cases have been added less than 5% FDI estimation errors; the reference signal is a sinusoid signal; and five different control mixer modules are tested, i.e.,

- (1) *static-1 method*: Matrix-module K_2 is calculated from $K_2 = B_f^+ B_n$ [8,14,11], where B_f^+ is the pseudo inverse of B_f ;
- (2) *static-2 method*: Matrix-module K_2 is calculated from $K_2 = (B_f K_{c1})^+ (A_n - A_f + B_n K_{c1})$ [5,12];
- (3) *RCM module* \mathcal{K}_1 : The module is synthesized from (5);
- (4) *RCM module* \mathcal{K}_4 : The module is synthesized from (6); and
- (5) *MORCM module* \mathcal{K}_1 : The module is synthesized from (11).

(I) *Actuator Fault $F_{k_t} = 0.1$ Case.* Here F_{k_t} means that the impaired motor torque constant will be $F_{k_t}k_t$. This fault caused large overshoots of the output angle (see Fig.9,10). The impaired system can be completely recovered using the static-1 and -2 methods due to the fact that both methods achieve perfect model-matching [6] if F_{k_t} can be provided precisely. The response using RCM \mathcal{K}_1 is shown in Fig.9 and $\gamma^* = 0.7962$ for this case. The response using RCM \mathcal{K}_4 is shown in Fig.10 and $\gamma^* = 1.126 \times e^{-3}$ for this case. It can be observed that RCM \mathcal{K}_4 provides better I/O function and performance recoveries than \mathcal{K}_1 .

(II) *Multiple Fault $F_{k_t} = 0.1$ and $F_c = 0.01$ Case.* This fault caused a quite large overshoots of the output angle. From Fig.11 it can be seen that the impaired system can only be partially recovered by static-1 method, while the reconfigured system using static-2 module completely lose the reference tracking ability. The response using RCM \mathcal{K}_1 is shown in Fig.12 and $\gamma^* = 0.3459$ for this case. The response using RCM \mathcal{K}_4 is shown in 13 and $\gamma^* = 1.127 \times e^{-3}$. The convergence of tracking errors can be observed in Fig.14, where case \mathcal{K}_4 has higher converging rate than case \mathcal{K}_1 .

(III) *Comparison of RCM and MORCM modules \mathcal{K}_1 .* Within the MORCM synthesis, only the angle tracking ability is considered, i.e., $y_{fc}^{perf} \hat{=} \Omega + \epsilon$. The responses using RCM and MORCM \mathcal{K}_1 are shown in Fig.15. Both methods can almost recover the tracking performance of the impaired system except that some static phase delays exist, which are mainly caused by dynamic compensators. It can be observed through Fig.16 that the MORCM case generates smoother trajectory and has smaller phase delay comparing with the RCM case.

6 Discussions and Conclusions

Comparing with the pseudo-inverse based methods, the RCM method systematically considers the stability, performance and robustness of the reconfigured system. The H_∞ control technique can be used for the module analysis and design after augmenting the optimal/suboptimal design problem into a standard H_∞ control synthesis problem through a model-matching strategy. The demonstrations based on a space robot system showed the proposed method have a wider applicable range and provide more design flexibility than pseudo-inverse based methods.

Comparing with the model-following methods discussed in [6,7], In the RCM synthesis model P_{nc} is not included in the developed RCM module for on-line running, therefore the complexity of this synthesis is relatively low. The RCM method still keeps the optimal/suboptimal sense when system uncertainties needed to be considered, especially, when the FDI uncertainty related to (3) need to be considered [17]. Instead of studying the perfect model-following conditions [6], here the solvability of RCM synthesis is explored and the infimum γ^* is used to evaluate the system reconfiguration.

Under the model-matching framework, some other techniques could also be em-

ployed for reconfigurable control synthesis, such as using the LQG control [7], the eigenstructure assignment [9]. Besides that, how to reduce the complexity of the designed modules and explore the cooperative design of multiple modules will be one aim of our future work.

References

- [1] M. Blanke, M. C. Frei, K. Kraus, R. J. Patton, and M. Staroswiecki. Fault-tolerant control of complex systems. In P. Albertos, K.J. Astrom, M. Blanke, A. Isidori, R. Santz, and W. Schaufelberger, editors, *Control of Complex Systems*. Springer-Verlag, 2000.
- [2] F. Caliskan. *Algorithms for Self-Repairing Real-Time Flight Control Systems*. PhD thesis, Dept. Aero. Eng., University of London, 1993.
- [3] B.A. Francis. *A Course in H_∞ Control Theory*. Springer-Verlag, 1987.
- [4] P. Gahinet and P. Apkarian. A linear matrix inequality approach to h_∞ control. *Int. J. Robust and Nonlinear Control*, 4:421–448, 1991.
- [5] Z. Gao and P.J. Antsaklis. Stability of the pseudo-inverse method for reconfigurable control systems. *Int. J. Control*, 53(3):717–729, 1991.
- [6] Z. Gao and P.J. Antsaklis. Reconfigurable control system design via perfect model following. *Int. J. Control*, 56(4):783–798, 1992.
- [7] C.Y. Huang and R.F. Stengel. Restructurable control using proportional-integral implicit model following. *Journal of Guidance, Dynamics and control*, 13(2):303–309, 1990.
- [8] R.R. Huber and B. McCulloch. Self-repairing flight control system. *Society of Automotive Engineers Tech. Paper 841552*, 1984.
- [9] J. Jiang. Design of reconfigurable control systems using eigenstructure assignments. *Int. J. Contr.*, 59(2), 1994.
- [10] S. Kanev and M. Verhaegen. Controller reconfiguration for non-linear systems. *Control Engineering Practice*, 8(11):1223–1235, 2000.
- [11] D. McLean and S. Aslam-Mir. Reconfigurable flight control systems. In *Int. Conf. On Control'91*, pages 234–242, 1991.
- [12] A.J. Ostroff. Techniques for accommodating control effector failures on a mildly statically unstable aircraft. In *Proc. ACC1985*, pages 903–906, 1985.
- [13] R.J. Patton. Fault-tolerant control: The 1997 situation. In *Proc. IFAC SafeProcess'97*, pages 1033–1055, 1997.
- [14] K.S. Rattan. Evaluation of control-mixer concept for reconfiguration of flight control systems. In *Proc. of 1985 IEEE National Aero. And Electro. Conference*, pages 560–569, 1985.

- [15] Z. Yang and M. Blanke. The robust control mixer module method for control reconfiguration. In *Proc. ACC2000*, pages 3407–3411, Chicago, Illinois, USA, June 2000.
- [16] Z. Yang and D. Hicks. Multiple objective robust control mixer method for synthesis of reconfigurable control. In *Proc. of ACC2002*, pages 5092–5097, Anchorage, Alaska, May 2002.
- [17] Z. Yang and Jakob Stoustrup. Design of robust reconfigurable control for parametric and additive faults. In *Proc. of 39th CDC*, pages 4132–4137, Sydney, Australia, December 2000.
- [18] K. Zhou, J.C. Doyle, and K. Glover, editors. *Robust and Optimal Control*. Prentice Hall, 1996.

Appendix A: Proof of Theorem 2:

According to the two-Riccati-Equation method [18], the optimal solution exists for

a plant described by the form $\left[\begin{array}{c|c|c} A & B_1 & B_2 \\ \hline C_1 & D_{11} & D_{12} \\ \hline C_2 & D_{21} & D_{22} \end{array} \right]$, if

- (1) (A, B_2, C_2) is stabilizable and detectable;
- (2) D_{12} is full column rank, and D_{21} is full row rank;
- (3) $\begin{bmatrix} j\omega I - A & B_2 \\ C_1 & D_{12} \end{bmatrix}$ is full column rank for all $0 \leq \omega \leq \infty$;
- (4) $\begin{bmatrix} j\omega I - A & B_1 \\ C_2 & D_{21} \end{bmatrix}$ is full row rank for all $0 \leq \omega \leq \infty$.

With respect to the \mathcal{K}_1 synthesis problem, the augmented plant in the standard configuration as shown in Fig.4 has the concrete form:

$$\left[\begin{array}{c|c|c} \left[\begin{array}{ccc} A_{nc} & 0 & 0 \\ 0 & A_{fc} & 0 \\ B_w C_{nc} & -B_w C_{fc} & A_w \end{array} \right] & \left[\begin{array}{cc} B_{nc} & E_{nc} \\ 0 & E_{fc} \\ B_w D_{nc} & B_w (G_{nc} - G_{fc}) \end{array} \right] & \left[\begin{array}{c} 0 \\ B_{fc} \\ -B_w D_{fc} \end{array} \right] \\ \hline \left[\begin{array}{ccc} D_w C_{nc} & -D_w C_{fc} & C_w \end{array} \right] & \left[\begin{array}{cc} D_w D_{nc} & D_w (G_{nc} - G_{fc}) \end{array} \right] & \left[\begin{array}{c} -D_w D_{fc} \end{array} \right] \\ \hline \left[\begin{array}{ccc} 0 & 0 & 0 \end{array} \right] & \left[\begin{array}{cc} I_{m_p \times m_p} & 0 \end{array} \right] & \left[\begin{array}{c} 0 \end{array} \right] \end{array} \right] \quad (12)$$

Consider that C_2 is a zero matrix, then A_{fc} , A_{nc} and A_w should be stable matrices so as to make condition (1) satisfied; It can be noted that $D_w D_{fc}$ is full column rank will make the (2) condition satisfied for the considered system. Furthermore, by checking condition (3) and (4), the other two conditions can be obtained under assumption that A_{nc} has no eigenvalues on the imaginary axis. \square

Appendix B: Proof of Theorem 4:

The plant in the augmented control structure as shown in Fig.5 can be described as:

$$\begin{bmatrix} z \\ y \end{bmatrix} = \begin{bmatrix} \mathcal{W}(s)(\mathcal{P}_{nc}(s) - \mathcal{P}_f(s)) & \mathcal{W}(s)\mathcal{P}_f(s) \\ \mathcal{C}(s)\mathcal{P}_f(s) & -\mathcal{C}(s)\mathcal{P}_f(s) \end{bmatrix} \begin{bmatrix} \begin{bmatrix} d \\ r \end{bmatrix} \\ 0 \\ u \end{bmatrix}. \quad (13)$$

Considering the impaired plant description (3), transfer matrix $\mathcal{P}_f(s)$ can be divided into two blocks as $[\mathcal{P}_{fd}(s) \ \mathcal{P}_{fu}(s)]$ with proper dimensions, i.e., $\mathcal{P}_{fu}(s) = D_f + (sI - A_f)^{-1}B_f$ and $\mathcal{P}_{fd}(s) = G_n + (sI - A_f)^{-1}E_n$. Then, (13) can be simplified into

$$\begin{bmatrix} z \\ y \end{bmatrix} = \begin{bmatrix} \mathcal{W}(s)(\mathcal{P}_{nc}(s) - \mathcal{P}_f(s)) & \mathcal{W}(s)\mathcal{P}_{fu}(s) \\ \mathcal{C}(s)\mathcal{P}_f(s) & -\mathcal{C}(s)\mathcal{P}_{fu}(s) \end{bmatrix} \begin{bmatrix} \begin{bmatrix} d \\ r \end{bmatrix} \\ u \end{bmatrix} \quad (14)$$

Then the controller \mathcal{K}_4 can stabilize this plant iff \mathcal{K}_4 can stabilize $\mathcal{C}\mathcal{P}_{fu}$ [3].

Bring a doubly-coprime factorization of $\mathcal{C}\mathcal{P}_{fu}$ as shown in (7), where $M_2, N_2, X_2, Y_2, \bar{M}_2, \bar{N}_2, \bar{X}_2, \bar{Y}_2 \in \mathcal{RH}_\infty$. Then the controller \mathcal{K}_4 stabilizing the augmented plant (14) can be parameterized as

$$\mathcal{K} = (Y_2 - M_2\mathcal{Q})(X_2 - N_2\mathcal{Q})^{-1} = (\bar{X}_2 - \mathcal{Q}\bar{N}_2)^{-1}(\bar{Y}_2 - \mathcal{Q}\bar{M}_2) \quad (15)$$

where $\mathcal{Q} \in \mathcal{RH}_\infty$. Define

$$\begin{aligned} \mathcal{T}_1 &\hat{=} \mathcal{W}(\mathcal{P}_{nc} - \mathcal{P}_f) + \mathcal{W}\mathcal{P}_{fd}M_2\bar{Y}_2\mathcal{C}\mathcal{P}_f \\ \mathcal{T}_2 &\hat{=} \mathcal{W}\mathcal{P}_{fu}M_2 \\ \mathcal{T}_3 &\hat{=} [\bar{M}_2\mathcal{C}\mathcal{P}_{fd} \quad -\bar{N}_2] \end{aligned} \quad (16)$$

Once the transfer functions \mathcal{P}_f , \mathcal{C} , \mathcal{W} and \mathcal{P}_{nc} are all real-rational and proper, there is $\mathcal{T}_i \in \mathcal{RH}_\infty$ for $i = 1, 2, 3$, and the transfer matrix $\mathcal{T}_{\omega z}$ of the closed-loop system

from $[d^T \ r^T]^T$ to z equals $\mathcal{T}_1 - \mathcal{T}_2 \mathcal{Q} \mathcal{T}_3$ [3]. Hereby, the H_∞ optimization problem (6) can be transferred into a model-matching problem

$$\min_{\mathcal{Q} \in \mathcal{RH}_\infty} \|(\mathcal{T}_1 - \mathcal{T}_2 \mathcal{Q} \mathcal{T}_3)\|_\infty. \quad (17)$$

With respect to the Theorem in Chapter 6 [3] (pp.62), the optimal solution for (17) exists if ranks of $\mathcal{T}_2(j\omega)$ and $\mathcal{T}_3(j\omega)$ are constant for all $0 \leq \omega \leq \infty$. The condition for constant rank of \mathcal{T}_2 can be guaranteed by properly designing \mathcal{W} . It can be noted that the condition $[\bar{M}_2 \mathcal{C} \mathcal{P}_{fd} \ - \ \bar{N}_2]$ has no zeros and poles on the imaginary axis guarantees the constant rank for \mathcal{T}_3 for all $0 \leq \omega \leq \infty$. \square

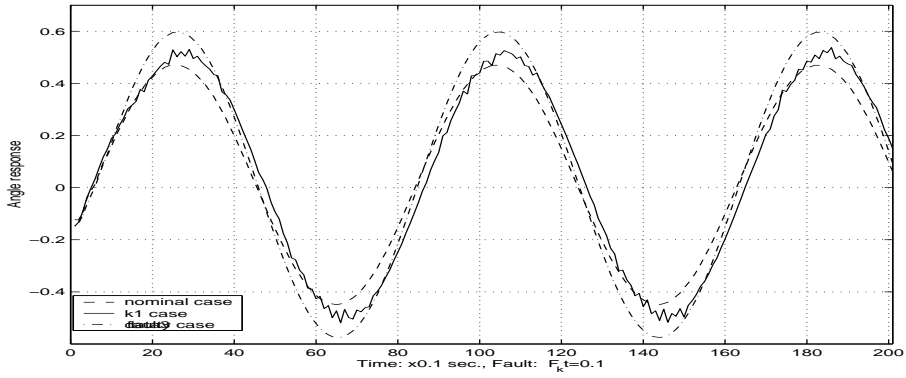

Fig. 9. Response angle of the reconfigured system constructed by \mathcal{K}_1

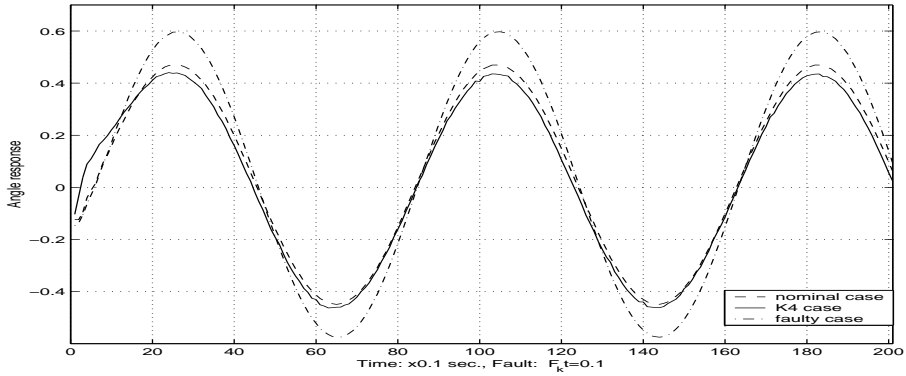

Fig. 10. Response angle of the reconfigured system constructed by \mathcal{K}_4

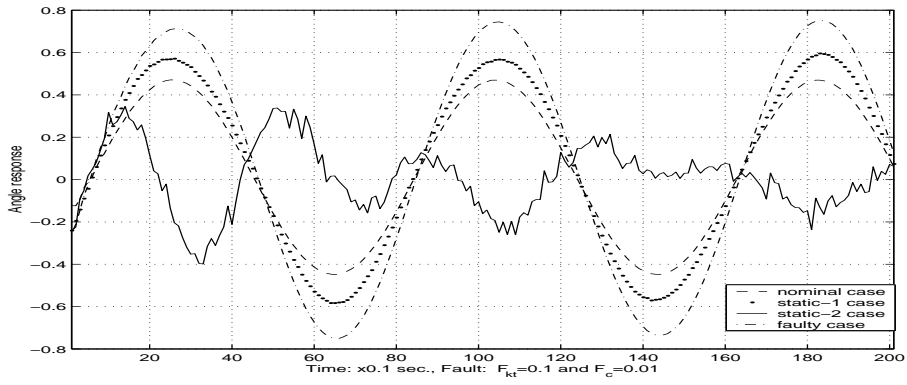

Fig. 11. Response angle of the reconfigured system constructed by static methods

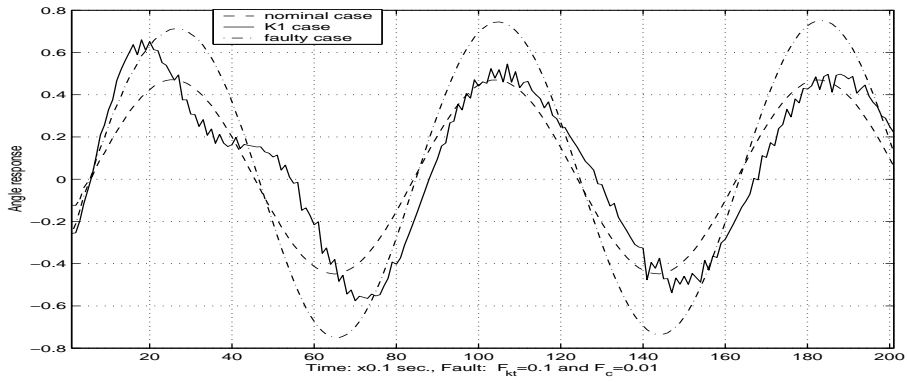

Fig. 12. Response angle of the reconfigured system constructed by \mathcal{K}_1

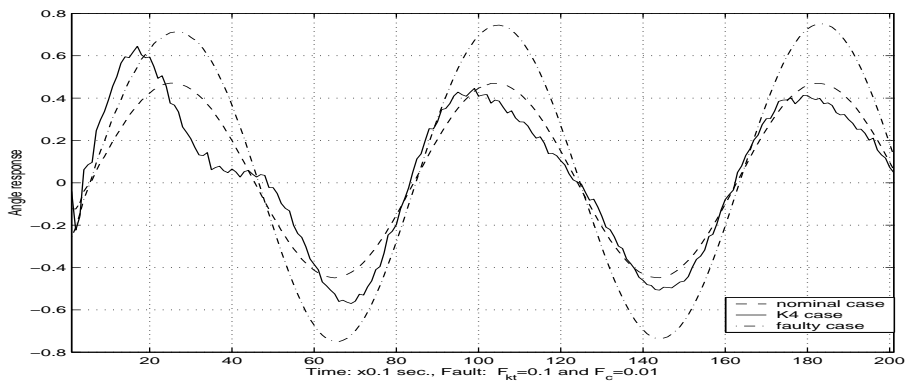

Fig. 13. Response angle of the reconfigured system constructed by \mathcal{K}_4

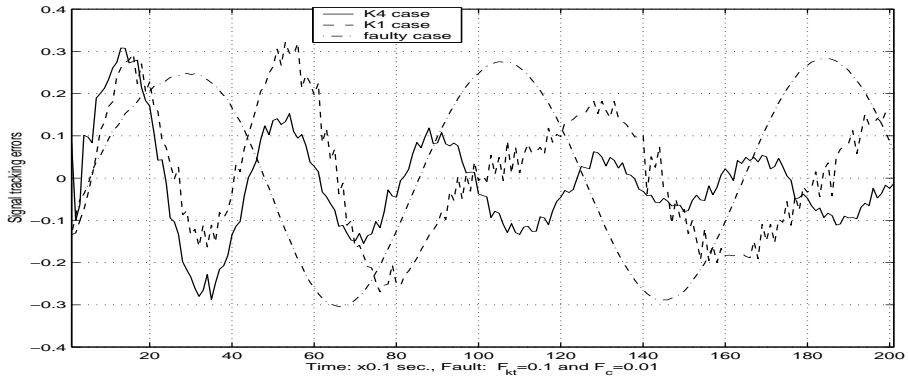

Fig. 14. Tracking errors under faulty, \mathcal{K}_1 and \mathcal{K}_4 cases

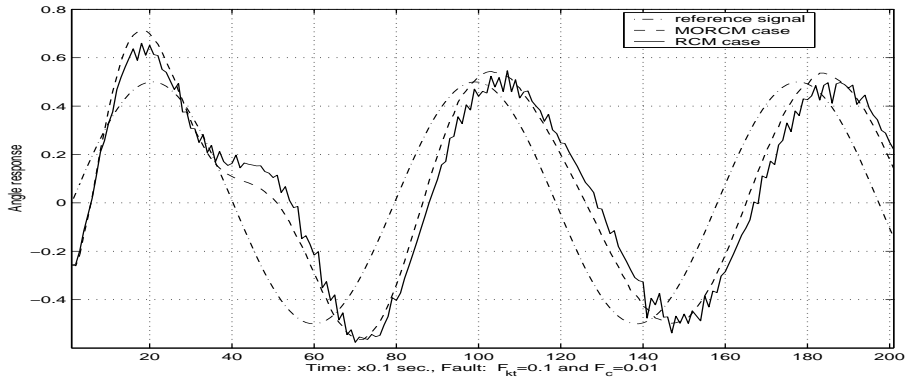

Fig. 15. Response angle of the system constructed by RCM and MORCM \mathcal{K}_1 s

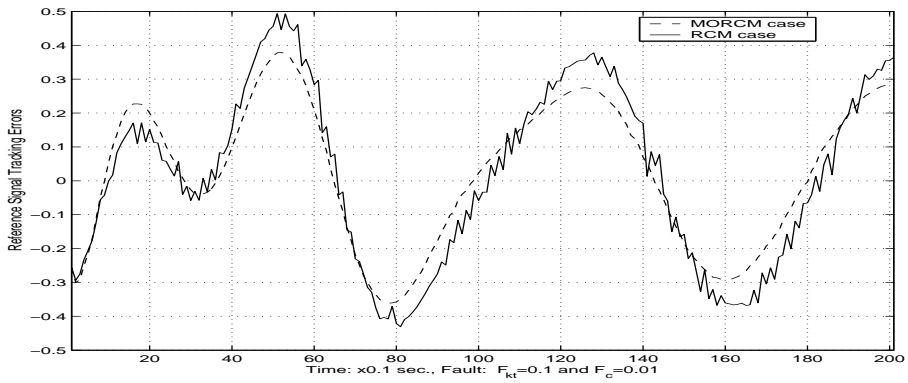

Fig. 16. Tracking errors under RCM and MORCM cases