



## Optically controlled reconfigurable antenna for 5G future broadband cellular communication networks

**Costa, I.F. da; Spadoti, D. H.; Cerqueira Sodre Jr., Arismar; Silva, Andréa Lema Da; Rodríguez Páez, Juan Sebastián; Puerta Ramírez, Rafael; Vegas Olmos, Juan José; Tafur Monroy, Idelfonso**

*Published in:*

Journal of Microwaves, Optoelectronics and Electromagnetic Applications

*Link to article, DOI:*

[10.1590/2179-10742017v16i1883](https://doi.org/10.1590/2179-10742017v16i1883)

*Publication date:*

2017

*Document Version*

Peer reviewed version

[Link back to DTU Orbit](#)

*Citation (APA):*

Costa, I. F. D., Spadoti, D. H., Cerqueira Sodre Jr., A., Silva, A. L. D., Rodríguez Páez, J. S., Puerta Ramírez, R., ... Tafur Monroy, I. (2017). Optically controlled reconfigurable antenna for 5G future broadband cellular communication networks. *Journal of Microwaves, Optoelectronics and Electromagnetic Applications*, 16(1), 208-217. DOI: 10.1590/2179-10742017v16i1883

---

### General rights

Copyright and moral rights for the publications made accessible in the public portal are retained by the authors and/or other copyright owners and it is a condition of accessing publications that users recognise and abide by the legal requirements associated with these rights.

- Users may download and print one copy of any publication from the public portal for the purpose of private study or research.
- You may not further distribute the material or use it for any profit-making activity or commercial gain
- You may freely distribute the URL identifying the publication in the public portal

If you believe that this document breaches copyright please contact us providing details, and we will remove access to the work immediately and investigate your claim.

# Optically controlled reconfigurable antenna for 5G future broadband cellular communication networks

Igor da Costa, Arismar Cerqueira Sodré Jr., Luis Gustavo da Silva, Juan Jose Vegas Olmos, Danilo Henrique Spadoti, Idelfonso Tafur Monroy

**Abstract**— This paper presents a new concept for future mobile backhaul systems operating in the lightly licensed 28 and 38 GHz frequency bands. These bands provide enough bandwidth to support the upcoming traffic raise, while maintaining a relatively low complexity in terms of electrical front-end, compared to higher frequency solutions, such as E- and W-band solutions. We present two key elements for the project: a broadband horn antenna for millimetre-wave and an optically controlled reconfigurable antenna, which can adapt its frequency response and radiation pattern by using photonics technology. Experimental results on 16-QAM and 32-QAM wireless transmission supported by photonic downconversion are successfully reported by using the developed antennas under 78 dB link budget requirement.

**Index Terms**— hybrid optical-wireless architecture; optically controlled antennas; photonic down conversion; reconfigurable antennas.

## I. INTRODUCTION

THE growing usage of wireless technology in consumer devices has saturated the lower-frequency bands (<10 GHz). Higher-frequency bands have been investigated for high-capacity wireless systems, especially in unlicensed or lightly licensed millimeter wave (mm-wave) frequency bands, such as the E-band (60-90 GHz), the W-band (75-110 GHz) and even the sub-terahertz band (100-300 GHz) [1-3]. Although optical technologies can provide solutions to generate and distribute such signals, the electrical front-ends for these frequency regimes are still under development.

This work was partially supported by Finep/Funttel Grant No. 01.14.0231.00, under the Radio Communications Reference Center (Centro de Referência em Radiocomunicações - CRR) project of the National Institute of Telecommunications, Brazil. Authors also thank the financial support from CNPq, CAPES, MCTI, FAPEMIG, COLCIENCIAS, and Marie Curie FIWIN5G, and technical support from Anritsu, Keysight, and ESSS-ANSYS.

I. F. da Costa and D.H.Spadoti are with the Federal University of Itajubá, Av. BPS 1303, Itajubá-MG, Brazil.

S. Rodriguez, R. Puerta, J. J. Vegas Olmos and I. T. Monroy, are with the Department of Photonics Engineering, Technical University of Denmark, Ørsted Plads, Building 343, 2800 Kgs. Lyngby, Denmark

Arismar Cerqueira S. Jr and L. G. da Silva are with the Laboratory WOCA (Wireless and Optical Convergent Access), National Institute of Telecommunications, Santa Rita do Sapucaí-MG, Brazil.

The 28 GHz and 39 GHz frequency bands represent an evolutionary solution that satisfies the additional bandwidth necessity. For this reason, these bands have been recognized as potential ones for future 5G broadband cellular communication networks [4, 5]. At these mm-wave bands,

unlike at 60 GHz and above, atmospheric absorption does not significantly contribute to additional path loss, thus making it a suitable candidate for indoor and outdoor mobile communication [6, 7].

Reconfigurable antennas have been shown to be interesting and promising for recent technologies of wireless communications systems [8, 9]. This class of antennas enables the bandwidth, radiation pattern and polarization reconfiguration by using frequency agile, software-defined, and cognitive radios to cope with extendable and reconfigurable multiservice, multistandard, and multiband operation as well as with efficient spectrum and power utilization. These new strategies can be efficiently applied to reduce the number of components, hardware complexity and cost compared to current radio technology, which relies on incompatible communication systems with inflexible hardware. Moreover, distributed antenna system (DAS) architectures have been shown to be efficient for wireless distribution, due to the reduced wireless coverage in the case of mm-wave links [10].

This work proposes the use of optically controlled reconfigurable antenna arrays (OCRAAs), operating in the lightly licensed 28 GHz and 39 GHz frequency bands. Using photoconductive switches allows to optically controlling its operational bandwidths and radiation pattern. The antenna presents a 90° half-power beamwidth in the azimuth plane, with the purpose of enabling the coverage of an indoor environment supported by photonic down conversion.

The remainder of this manuscript is organized as follows. Section 2 presents the development of the optically controlled antenna array for the 28 GHz and 39 GHz frequency bands. Section 3 describes the experimental setups and the used photonic down conversion architectures. Section 4 reports the optical-wireless network implementation and its performance evaluation. Finally, conclusions and future work are addressed in Section 5.

## II. OPTICALLY RECONFIGURABLE SLOTTED WAVEGUIDE ANTENNA ARRAY

To support the indoor wireless transmissions it is necessary an antenna capable to have a half-power beamwidth of at least 90° to provide a good indoor coverage.

Slotted waveguide antenna arrays (SWAA) are one of the antenna design that can give a good aperture in the azimuth plane and still maintaining the gain. The structure consists of lengths of waveguide with slots milled into its conducting walls. The slots are excited by the guided wave inside the antenna, radiating the signal thru the slots into the air. This

antenna design presents a rugged and compact structure, low loss, high gain, and a easy project based in the design procedures published by Elliot [11, 12]. The high gain is necessary to handle free space losses, which are natural for the mm-wave frequency range. For those reasons we choose this antenna design. The developed SWAA is based in a novel structure with two different slots for 28GHz and 38GHz.

Furthermore reconfigurable technologies exhibited great promise for the next generation of wireless systems [13]. There are many different methods to change the antenna characteristics, in particular optical control have been exploited in recent years due to advantages as absence of bias lines, elimination of radiation pattern distortion and easy integration into optical systems [14-17].

The technique is based on photoconductive switches, made of semiconductor material (silicon or gallium arsenide) [18]. As soon as the switch is illuminated by a 808 nm laser, the silicon changes from an insulator state to a near- conducting state by creating electron-hole pairs.

Depending where we put the switch it is possible to control return loss, radiation pattern and polarization. The switch operation is basically “On” for when the laser is turned on and “Off” when there is no light at the silicon. Therefore, it is possible to manage the switch conductivity by controlling the optical incident power [13].

The proposed optically controlled slotted-waveguide antenna array shown in Fig. 1, are composed by a waveguide with slots for 28 and 38GHz and two optical switches to control with frequency band will radiate, in this way is possible to remote control the antenna frequency band.

The final design has a directive radiation pattern with 90° half-power beamwidth in the azimuth plane and two possible frequency bands, one covers from 27.6 to 30,8GHz with 8dBi of gain and the other one from 36,8 to 38,4GHz with 9dBi of gain.



Fig. 1. The SWAA multiband design based on two different slot lengths.

### III. PHOTONIC DOWN CONVERSION AND EXPERIMENTAL SETUPS

A microwave downconverter, which is used to convert a high-frequency RF signal to the baseband or the intermediate

frequency band for further processing, is an essential component applied in a variety of applications, such as wireless communication systems, cellular networks, phased-array antennas, radars and electronic warfare systems.

Conventionally, a microwave downconverter can be realized using an electrical mixer in which an electrical local oscillator (LO) at  $f_{RF}$  is mixed with the electrical signal at  $f_s$ , resulting in an intermediate frequency (IF)  $f_{IF} = f_{RF} \pm f_s$ , which falls within the bandwidth of the analog-to-digital converter (A/D). The conventional downconverters suffer from the limitations of narrow operation bandwidth, low isolation, severe distortion and low conversion efficiency. Photonic down conversion (PDC) [21] has shown the potential to overcome these shortcomings and is thus considered an effective solution, with advantages such as an extremely wide operation bandwidth, high isolation and immunity to electromagnetic interference. PDC has been recognized as an efficient way to extend the frequency range of digital coherent receivers beyond a few gigahertz.

Many photonic downconverters have been proposed, most of which are realized by two cascaded electro-optic modulators [19-21]. The main advantages of the PDC scheme based on the cascaded modulators is the high isolation between the RF and LO ports, the large operation bandwidth provided by the electro-optic modulators, and the high stability and low jitter of optical-pulsed sources. Additionally, the use of PDC enables the detection of extremely high RFs, which eventually exceed the bandwidth of the A/D converter.

We have applied two different PDC strategies for evaluating the proposed optically controlled antenna array. Fig.2 presents the first approach is based on two Mach-Zehnder modulators (MZMs). A local oscillator (LO) and an RF signal to be down converted are applied to the two modulators to perform the frequency mixing in the optical domain. After photodetection, the microwave signal is down converted to the desired frequency band. The RF signal is generated using a vector signal generator (VSG) with an internal analog digital converter. It provides 40 Mbaud 32-QAM and 64-QAM at frequencies up to 40 GHz. Its output is fed into the optical controlled antenna at a RF power of 5.0 dBm. Then, the RF signal is transmitted through a 5 m wireless link and received by the broadband horn antenna. The signal is amplified using a double-stage, low-noise amplifier (LNA) with a gain of 30 dB and a power amplifier (PA) with a gain of 21 dB and a noise figure of less than 6 dB. The first MZM is biased at the minimum point to create three tones spaced by the local oscillator (LO) frequency, typically from 27 GHz to 31 GHz. Afterwards, a second MZM is used to modulate these three tones with the received and amplified wireless signal. The optical signal is amplified and filtered to remove the undesired components. At the photodiode, the beating of the central carrier with the information from the upper and lower modulated tones results in the information being down converted to an intermediate frequency, corresponding to the difference between the LO and RF signals (typically from 4 GHz to 10 GHz). The IF signal following the photodiode is amplified and sampled using a digital storage oscilloscope (DSO) to perform digital

demodulation and error vector magnitude (EVM) measurement.

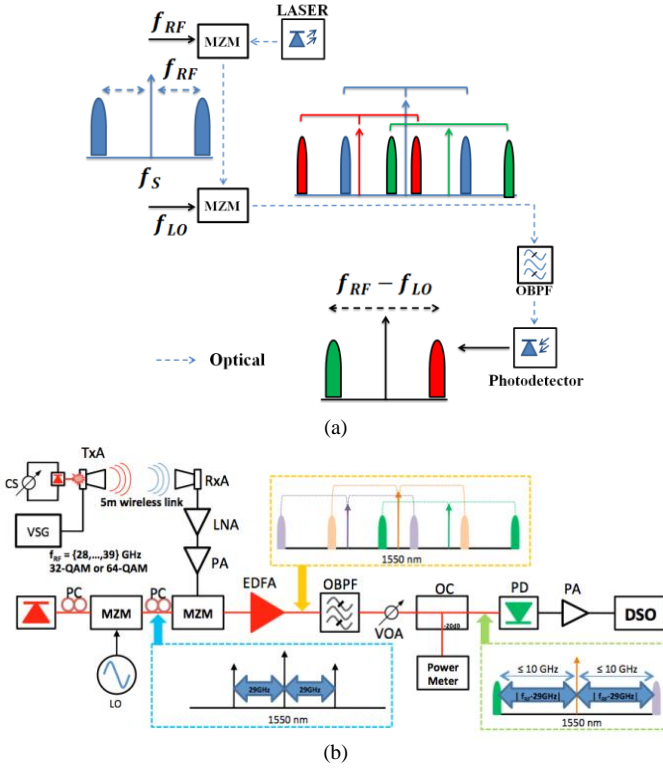

Fig. 2. The first approach for PDC: CS: current source, TxA: transmitting antenna, RxA: receiving antenna, PC: polarization controller, EDFA: erbium doped fiber amplifier, OBPF: optical band pass filter, VOA: variable optical attenuator, PD: photodetector, PA: power amplifier, DSO: digital storage oscilloscope. (a) Schematic. (b) Experimental setup.

The second photonic down conversion approach is based on all-optical half-wave rectification technique [22]. The experimental setup is presented in Fig. 3. A pseudorandom binary sequence with a data of length  $2^{15}-1$  at 1.25Gb/s bit rate is generated in the pulse pattern generator (PPG). VSG uses the signal generated by PPG to feed its internal mixer, up converting the carrier frequency at 28 GHz or 39GHz with amplitude-shift keying (ASK) modulation. The RF output is amplified using a 20dBm linear amplifier before feeding the transmission OCRAA at 20dBm. Finally, a 3 m wireless network is ensured by applying another OCRAA for data reception.

In the reception part, the signal is then amplified using a double-stage linear amplifier with 23 dB gain. After the amplification stage, the RF signal is connected to the MZM electrical input. The unique MZM is biased at the minimum point, in such a way that the half-wave rectification effect is achieved as shown in the inset of Fig. 3 [23]. In this setup, the PD used to recover the data will act as a filter by means of working as an envelope detector, which gives us the original sequence in baseband [24]. A DSO is used to experimentally investigate the bit error rate (BER), using offline digital signal processing, by comparing the received data signal with the original sequence generated by PPG.

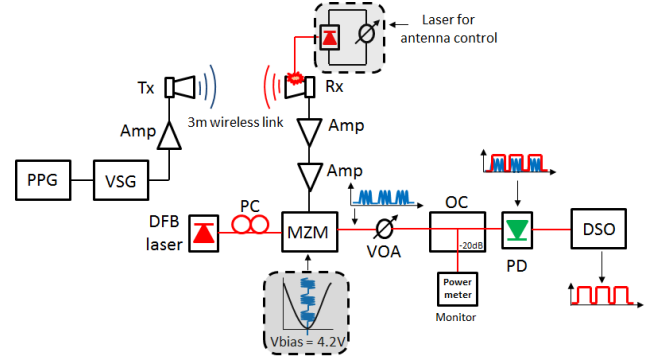

Fig. 3. Experimental setup of the second photonic downconversion approach, including the pulse pattern generator.

#### IV. PERFORMANCE ANALYSIS

This section reports the experimental results for the wireless transmission using the developed OCRAAs, a broadband horn antenna and a photonic down conversion techniques. The experiments have been carried in an indoor environment using four different scenarios.

The first one is focused on the implementation and applicability analysis of the optically controlled reconfigurable system. As described in the previous section, the antenna frequency bands can be efficiently managed by optimizing the incident optical power into the photoconductive switches. Its gain at 39 GHz can be significantly enhanced by 6.38 dB, from 2.62 dBi to 9.0 dBi, by illuminating the photoconductive switch, i.e., turning it to the “On-state”. The OCRAA has been used to transmit the RF signal, whereas a broadband horn antenna has been applied to increase its transmission distance to 5 m. The experiments have been conducted at 39 GHz, which is the upper limit of the second bandwidth from OCRAA. The free-space loss, calculated by the Friis Equation, is 78.24 dB at 39 GHz for 5 m distance. Fig. 4a and b report the results of the performance investigation for a 32-QAM signal as a function of the electrical signal-to-noise ratio (SNR) and  $EVM_{RMS}$ , respectively. Both are plotted with respect to the applied current at the controller laser used to reconfigure the antenna properties.

The constellation has been shown to be extremely poor for the “Off-state” of the photoconductive switch, and thus, the measured  $EVM_{RMS}$  was 12.2%. A higher laser current results in a higher  $EVM_{RMS}$ , reaching 4.8% for 3.5A, as shown in Fig. 4b. The measured constellation for this laser condition was excellent, as highlighted in the top-right inset of the figure. The SNR was also increased by 8 dB, as illustrated in Fig. 4a. Finally, Fig. 4c illustrates a success implementation of 64-QAM at 38 GHz using OCRAA and PDC. The beating between the LO and RF signals was at 7 GHz with power of -12 dBm. The obtained  $EVM_{RMS}$  was 6.38% for this case.

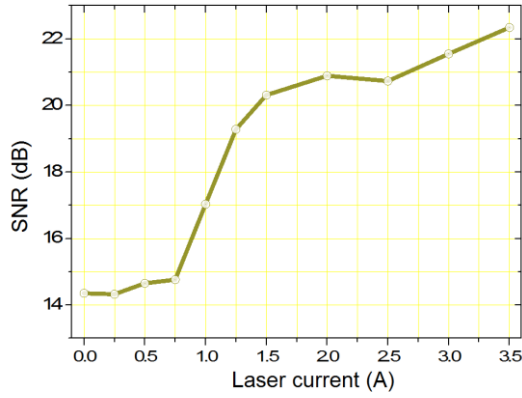

(a)

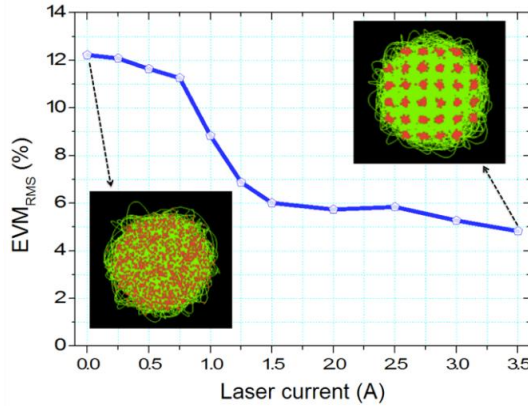

(b)

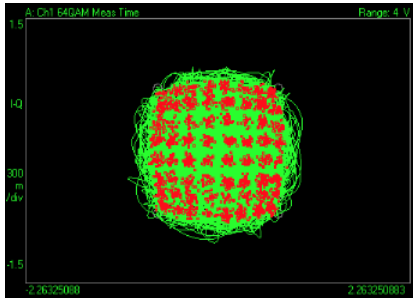

(c)

Fig. 4. Experimental investigation at 39 GHz wireless transmission with photonic downconversion using one horn broadband antenna and the proposed OCRF-SWAA. (a) SNR as a function of laser current. (b) EVM as a function of laser current. (c) 64-QAM constellation with  $EVM_{RMS} = 6.38\%$ .

These experimental results demonstrate the frequency-agile and optically steerable antenna properties that can be efficiently applied to the implementation of an adaptive wireless system in the mm-wave frequency range. To the best of our knowledge, these are the first published performance results reporting the  $EVM_{RMS}$  and SNR as a function of the incident optical power into a photoconductive switch.

The other three setups were focused on evaluating the system performance as function of BER by using two OCRAAs distanced by 3 meters, as shown in Fig. 5. For comparison purposes, the second setup had been the best possible scenario (BS), i.e. a back-to-back scenario by directly connecting the VSG to the MZM RF input. In other words, there is no wireless transmission in this setup. On the other hand, in the

third setup, we have used a pair of slotted-waveguide antenna arrays without any reconfiguration. In this manner, the gain and radiation pattern of OCRAA, but the frequency band is fixed, allowing us to properly evaluate the impact of using optical reconfiguration.

The last setup is presented in Fig. 5, in which two OCRAAs have been used to transmit and to receive the on-off keying non return to zero (OOK-NRZ) signal. A variable optical attenuator (VOA) has been included to control the optical input power at the PD in order to enable to obtain BER curves as a function of the optical input power in steps of 0.5dB.

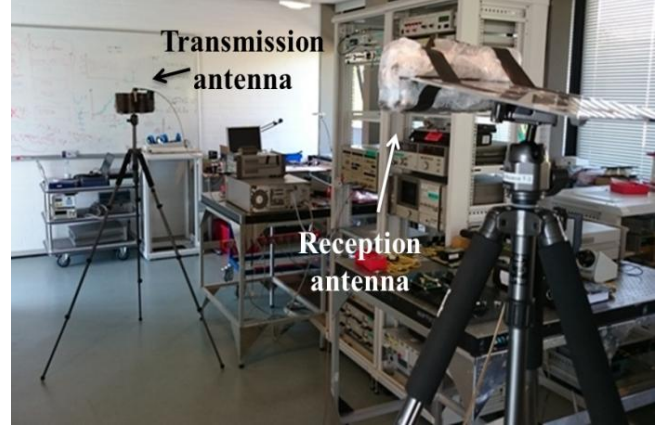

Fig. 5. Wireless setup used for the BER measurements.

Fig. 6 reports an experimental for the 28 and 39 GHz frequency bands in an indoor environment. Therefore the RF signals were subjected to intense fading due to multipath. As shown in Section III, the proposed OCRAA provides a wider beamwidth in the azimuth plane for the 28 GHz band, when compared to 39 GHz one. This characteristic decreases the total gain, provides a greater spatial coverage at the price of increasing the multipath effect. For the maximum received optical power, the BER at 28GHz is  $10^{-2.4}$  using the OCRAA and  $10^{-1.9}$  for the non-reconfigurable system. The difference between the wireless setups and the best scenario is clear, once, for a received power at the PD of  $-22\text{dBm}$  the BER for BS is  $10^{-4.6}$ , whereas for the wireless setups the best result is  $10^{-2.4}$ . Fig. 7 presents the BER variation as a function of the laser current used to reconfigure the OCRAA electromagnetic properties. From the best result obtained using two OCRAAs, we have decreased the laser current until turn it off.

By feeding the laser with 2.5A, we have reached an output optical power of approximately 2 W, which results in a BER of  $10^{-4.6}$ . BER was gradually decreasing as soon as the laser current was reduced, resulting in  $10^{-3.1}$  for the switch “off” state. The same behavior can be observed in the eye diagram analysis. For the “On-state”, the eye height and SNR are 3.3mV and 4.1 respectively. On the other hand, they are significantly degraded to 1.7mV and 3.5 for the “Off-state” in all scenarios.

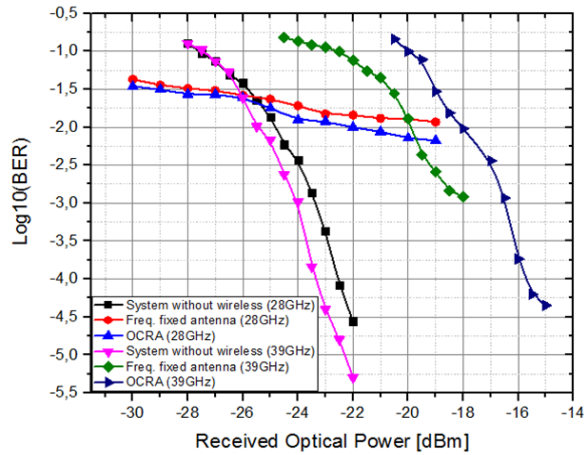

Fig.6. The performance analysis as a function of BER for 28 and 39 GHz frequency bands.

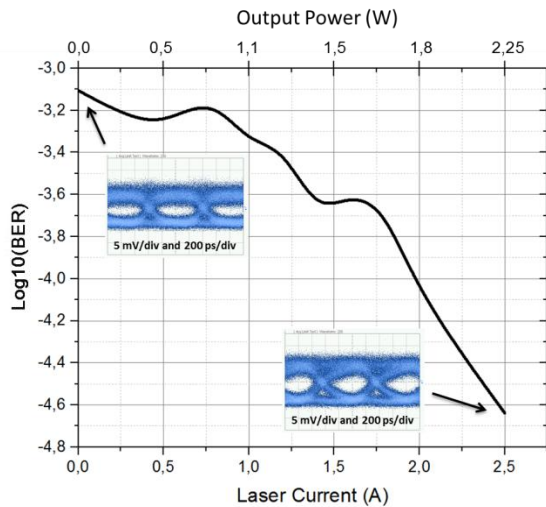

Fig. 7. Measured BER as function of the laser control current at 39GHz.

The results are very promising for 39GHz, since the antenna without reconfiguration presented a slightly better performance. It becomes necessary to increase the optical power at PD input by 2dB in order to reach the same BER using OCRAAs.. This power penalty can be accepted in face of the advantage to be able to implement an optical-wireless network using only one antenna, which can be remotely and optically reconfigured as a function of the radio mobile environment.

## V. CONCLUSIONS

An optically controlled reconfigurable antenna for mm-wave applications has been proposed, developed and success implemented. Its frequency response could be efficiently reconfigured in the optical domain by using a photoconductive switch and an 808 nm laser. The proposed OCRAA enables frequency response management in two different ways: operation in the 28 GHz band; and operation in the 39 GHz band. Its main advantage relies on the fact the antenna reconfigurability is not dependent of the photoconductive switch rise-time. In this manner, we significantly enhance the

degrees of freedom of the antenna design, opening new possibilities in the development of reconfigurable antennas for mm-wave frequency range and so on.

We have experimentally evaluated the antenna performance using four different indoor scenarios using two different approaches for photonic downconversion. In the first setup, experimental results on 40 Mbaud with complex modulation formats up to 64-QAM wireless transmission supported by photonic downconversion were successfully reported under a 78 dB link budget requirement. The measured  $EVM_{RMS}$  has been gradually enhanced from 12.2% to 4.8% and SNR increased from 14.15 to 22.3, by increasing the optical power launched into the photoconductive switch. To the best of our knowledge, these are the first published performance results reporting the  $EVM_{RMS}$  and SNR as a function of the incident optical power into a photoconductive switch.

An all-optical half-wave rectifier has also been successfully implemented to enable frequency downconversion at the receiver side. Two OCRAAs have been simultaneously applied for indoor transmission of 1.25 Gb/s data signal with a 3m coverage. BER measurements have been conducted for the 28 and 39 GHz frequency band. The best-obtained BER were  $10^{-2.4}$  and  $10^{-4.4}$  at 28 and 39GHz, respectively. Future works regards the development of OCRAAs for higher frequency ranges.

## REFERENCES

- [1] J. J. V. Olmos, T. Kuri, K. Kitayama, "Reconfigurable Radio-Over-Fiber Networks: Multiple-Access Functionality Directly Over the Optical Layer," *IEEE Transactions on Microwave Theory and Techniques*, vol. 58, no. 11, pp. 3001-3010, Nov. 2010.
- [2] S. Koenig, F. Boes, D. Lopez-Diaz, J. Antes, R. Henneberger, R. Schmogrow, D. Hillerkuss, R. Palmer, T. Zwick, C. Koos, W. Freude, O. Ambacher, I. Kallfass, J. Leuthold, "100 Gbit/s Wireless Link with Mm-wave Photonics," in *Proc. Optical Fiber Communication Conference and Exposition and the National Fiber Optic Engineers Conference (OFC/NFOEC)*, Mar. 2013, pp. 1-3.
- [3] J. J. V. Olmos, I. T. Monroy, "Fiber-wireless Links Supporting High-capacity W-band Channels," in *Proc. Progress in Electromagnetics Research Symposium (PIERS)*, Aug. 2013.
- [4] T. S. Rappaport, S. Shu, R. Mayzus, Z. Hang, Y. Azar, K. Wang, G. N. Wong, J. K. Schulz, M. Samimi, F. Gutierrez, "Millimeter Wave Mobile Communications for 5G Cellular: It Will Work!," *IEEE Access*, vol. 1, pp. 335-349, May 2013.
- [5] T. S. Rappaport, J. N. Murdock, F. Gutierrez, "State of the Art in 60-GHz Integrated Circuits and Systems for Wireless Communications," *Proceedings of the IEEE*, vol. 99, no. 8, pp. 1390-1436, Aug. 2011.
- [6] Z. Pi, F. Khan, "An Introduction to Millimeter-wave Mobile Broadband Systems," *IEEE Communications Magazine*, vol. 49, no. 6, pp. 101-107, June 2011.
- [7] P. F. M. Smulders, L. M. Correia, "Characterisation of Propagation in 60 GHz Radio Channels," *Electronics & Communication Engineering Journal*, vol. 9, no. 2, pp. 73-80, Apr. 1997.
- [8] C. G. Christodoulou, Y. Tawk, S. A. Lane, S. R. Erwin, "Reconfigurable Antennas for Wireless and Space Applications," *Proceedings of the IEEE*, vol. 100, no. 7, pp. 2250-2261, July 2012.
- [9] A. C. Sodré, I. F. da Costa, L. T. Manera, J. A. Diniz, "Optically Controlled Reconfigurable Antenna Array Based on E-Shaped Elements," *International Journal of Antennas and Propagation*, vol. 2014, 2014.
- [10] A. M. J. Koonen, M. G. Larrodé, "Radio-Over-MMF Techniques Part II: Microwave to Millimeter-Wave Systems," *Journal of Lightwave Technology*, vol. 26, no. 15, pp. 2396-2408, Aug. 2008.
- [11] J. L. Volakis, "Antenna Engineering Handbook," 4th ed., 2007.

- [12] R. S. Elliot, L. A. Kurtz, "The Design of Small Slot Arrays," *IEEE Transactions on Antennas and Propagation*, vol. 26, no. 2, pp. 214-219, Mar. 1978.
- [13] J. Costantine, Y. Tawk, S. E. Barbin, C. G. Christodoulou, "Reconfigurable Antennas: Design and Applications," *Proceedings of the IEEE*, vol. 103, no. 3, pp. 424-437, Mar. 2015.
- [14] Y. Tawk, A. R. Albrecht, S. Hemmady, G. Balakrishnan, C. G. Christodoulou, "Optically Pumped Frequency Reconfigurable Antenna Design," *IEEE Antennas and Wireless Propagation Letters*, vol. 9, pp. 280-283, Apr. 2010.
- [15] Y. Tawk, J. Costantine, S. Hemmady, G. Balakrishnan, K. Avery, C. G. Christodoulou, "Demonstration of a Cognitive Radio Front End Using an Optically Pumped Reconfigurable Antenna System (OPRAS)," *IEEE Transactions on Antennas and Propagation*, vol. 60, no. 2, pp. 1075-1083, Feb. 2012.
- [16] C. J. Panagamuwa, A. Chauraya, J. C. Vardaxoglou, "Frequency and Beam Reconfigurable Antenna Using Photoconducting Switches," *IEEE Transactions on Antennas and Propagation*, vol. 54, no. 2, pp. 449-454, Feb. 2006.
- [17] E. K. Kowalczyk, R. D. Seager, C. J. Panagamuwa, K. Bass, J. C. Vardaxoglou, "Optimising the Performance of an Optically Controlled Microwave Switch," in *Proc. Loughborough Antennas and Propagation Conference (LAPC)*, Nov. 2012, pp. 1-5.
- [18] C. Kittel, "Introduction to Solid State Physics," 7th ed. New York: Wiley, 1996.
- [19] T. R. Clark, S. R. O'Connor, M. L. Dennis, "A Phase-Modulation I/Q-Demodulation Microwave-to-Digital Photonic Link," *IEEE Transactions on Microwave Theory and Techniques*, vol. 58, no. 11, pp. 3039-3058, Nov. 2010.
- [20] A. Caballero, D. Zibar, I. T. Monroy, "Performance Evaluation of Digital Coherent Receivers for Phase-Modulated Radio-Over-Fiber Links," *Journal of Lightwave Technology*, vol. 29, no. 21, pp. 3282-3292, Nov. 2011.
- [21] T. Zhang, W. Pan, X. Zou, B. Luo, L. Yan, X. Liu, B. Lu, "High-spectral-efficiency Photonic Frequency Down-conversion using Optical Frequency Comb and SSB Modulation," *IEEE Photonics Journal*, vol. 5, no. 2, Apr. 2013.
- [22] K. Prince, I. T. Monroy, J. Seoane, P. Jeppesen, "All-optical Envelope Detection for Radio-over-Fiber links using External Optical Injection of a DFB Laser," *Optics Express*, vol. 16, no. 3, pp. 2005-2014, Feb. 2005.
- [23] K. Prince, I. T. Monroy, "All-optical Envelope Detection and Fiber Transmission of Wireless Signals by External Injection of a DFB Laser," *IEEE Photonics Technology Letters*, vol. 20, no. 15, pp. 1317-1319, Aug. 2008.
- [24] K. Prince, I. T. Monroy, "Multi-band Radio Over Fiber System with All-optical Halfwave Rectification, Transmission and Frequency Down-conversion," *Elsevier Optical Fiber Technology*, vol. 7, no. 4, pp.310-314, July 2011.