



Model Identification for Control of Display Units in Supermarket Refrigeration Systems

O'Connell, Niamh; Madsen, Henrik; Andersen, Philip Hvidthøft Delff; Pinson, Pierre; O'Malley, Mark

Publication date:
2014

Document Version
Publisher's PDF, also known as Version of record

[Link back to DTU Orbit](#)

Citation (APA):

O'Connell, N., Madsen, H., Andersen, P. H. D., Pinson, P., & O'Malley, M. (2014). Model Identification for Control of Display Units in Supermarket Refrigeration Systems. Kgs. Lyngby: Technical University of Denmark (DTU). (DTU Compute-Technical Report-2014; No. 2).

DTU Library

Technical Information Center of Denmark

General rights

Copyright and moral rights for the publications made accessible in the public portal are retained by the authors and/or other copyright owners and it is a condition of accessing publications that users recognise and abide by the legal requirements associated with these rights.

- Users may download and print one copy of any publication from the public portal for the purpose of private study or research.
- You may not further distribute the material or use it for any profit-making activity or commercial gain
- You may freely distribute the URL identifying the publication in the public portal

If you believe that this document breaches copyright please contact us providing details, and we will remove access to the work immediately and investigate your claim.

Model Identification for Control of Display Units in Supermarket Refrigeration Systems

Niamh O’Connell^{a,*}, Henrik Madsen^a, Philip Delff^a, Pierre Pinson^b, Mark O’Malley^c

^a Department of Applied Mathematics and Computer Science, Technical University of Denmark

^b Department of Electrical Engineering, Technical University of Denmark

^c Department of Electrical Engineering, University College Dublin

Abstract

In this paper we propose a method for identifying and validating a model of the heat dynamics of a supermarket refrigeration display case for the purpose of advanced control. The model is established to facilitate the development of novel model-based control techniques for individual display units in a supermarket refrigeration system. The grey-box modelling approach is adopted, using stochastic differential equations to define the dynamics of the model, combining prior knowledge of the physical system with data-driven modelling. Model identification is performed using the forward selection method, and the performance of candidate models is evaluated through cross-validation. The model developed in this work uses operational data from a small Danish supermarket. A three-state model is determined to be most appropriate for describing the dynamics of this system. Advanced local control employing the identified model can contribute to the extension of the control capabilities of the entire supermarket refrigeration system.

Keywords: Grey-Box Modelling, System Identification, Model-Based Control, Demand Response, Semi-Physical Modelling, Refrigeration

1 Introduction

The transition from passive control strategies such as hysteresis or threshold-based control to model-based control for refrigeration display units can contribute to the optimised operation of the entire refrigeration system. This will offer opportunities for improved energy efficiency, reduced operating costs when subject to time-varying electricity prices, and participation in the smart-grid through the provision of demand response.

The thermal mass of the foodstuff stored within the display units of a refrigeration system provides a form of energy storage, allowing power consumption to be shifted in time while maintaining acceptable temperatures for food storage. This potential for flexibility in power consumption is attracting significant research attention due to the perceived benefits for both the supermarket operator and the power

*Corresponding author:
Technical University of Denmark
Department of Applied Mathematics and Computer Science
Asmussens Allé, Building 303B, DK-2800 Kgs. Lyngby, Denmark
Tel: +45 4525 3369, email: noco@dtu.dk

system [Pedersen et al., 2013, 2014, Hovgaard et al., 2013, Shafiei et al., 2013]. Supermarkets represent a sizeable share of national electricity consumption, at 2% (550GWh) and 4% (1.8TWh) in Denmark and Sweden respectively [Hovgaard et al., 2013, Arias, 2005], of which refrigeration accounts for up to 47% [Furberg and Norberg, 2000]. Activating flexibility within this volume of electricity demand could represent a significant resource to the power system, with a range of applications from managing distribution system congestion to providing regulating power to maintain the balance of supply and demand in real-time. The primary benefit of flexible power consumption to the supermarket operator is the potential reduction in operating costs. Electricity costs make up only 1% of costs for the typical supermarket, however with a typical profit margin of only 3% any savings in energy costs would translate to an increase in profit [Arias, 2005].

In order to realise this potential flexibility in power consumption it must be possible to control the refrigeration system in an intelligent manner. Control of the refrigeration system occurs on two distinct levels: supervisory and local. Supervisory control concerns the operation of the centralised system components such as the compressor banks and suction manifold, and affects the power consumption of the system and the temperature of the refrigerant supplied to the display units. Local control focusses on the individual display unit within the larger refrigeration system, overseeing the variations in local temperatures, which are subject to the temperature of the refrigerant supplied by the supervisory system.

This work focusses on facilitating advanced model-based control at the local control level, through the identification and validation of a grey-box model of a display unit using operational data from a supermarket in Denmark. Advanced control at this level will extend the capabilities of the supervisory controller and subsequently facilitate flexibility in power consumption.

The general area of demand response, or optimised power consumption, in thermal-electric applications such as building heating and cooling, water heating, and refrigeration systems is currently the subject of intensive research effort. The potential for residential buildings to shift electrical demand in their heating systems by up to 10 hours is demonstrated by Corradi et al. [2013], while the peak load reduction and cost saving capabilities of residential heating, ventilation, and air conditioning (HVAC) systems are discussed by Yoon et al. [2014]. Demand response from refrigeration is proposed for the provision of frequency regulation by Nyeng et al. [2010] and Angeli and Kountouriotis [2012], while the ability of refrigeration systems to respond to time-varying prices is demonstrated by Shafiei et al. [2013].

Grey-box modelling has been employed to identify models of residential buildings that are suitable for demand response, [Bacher and Madsen, 2011, Andersen et al., 2014], however there is a dearth of such models within the field of supermarket refrigeration. Grey-box modelling is employed by Costanzo et al. [2013] for the estimation of models for household refrigerators, however these are substantially simpler than their supermarket counterparts. In household refrigerators a single control system governs all stages of the thermodynamic cycle, from power consumption to refrigeration temperature. Control of cold storage refrigeration for demand response is described by Pedersen et al. [2013], however the model employed for control is a simplified state-space model which is insufficient for accurate control at the local level. Demand response from supermarket refrigeration systems is considered by Hovgaard et al. [2013] and Shafiei et al. [2013], where models for control are developed from first principles and using ordinary differential equations (ODEs), respectively.

The contribution of this work lies in the employment of stochastic differential equations (SDEs) to model this inherently stochastic system, and the focus on the local control system. The supermarket refrigeration display case is subject to a number of stochastic stimuli that are not considered within traditional ODE models. These include the opening and closing of insulating doors, the addition and removal of foodstuffs and the thermal interactions with passing customers and staff. SDE-based models account for such stochasticity by allowing for noise in both the modelled process and the measurement of the temperature under control.

Furthermore, the model-based control architectures commonly proposed for applications in demand response will require models such as that presented in this paper that can accurately represent highly complex and stochastic systems. Model-based control architectures are considered for a wide range of demand response applications, including for building climate control [Oldewurtel et al., 2012], control of thermal storage for power balancing [Halvgaard et al., 2013], control of commercial refrigeration

[Hovgaard et al., 2013], and as the basis of large-scale control architectures for automated control of demand response resources on the power system [Lampropoulos et al., 2012]. The emergence of model-based control as a favoured option among other candidate control schemes is likely due to the increased efficiency of model predictive control architectures over their conventional counterparts, as well as the availability of computational resources for the identification of models for this control strategy [Oldewurtel et al., 2012]. Controlling such systems also requires knowledge about system states (e.g. temperatures) that it may not be possible to measure directly, but which can be estimated using the grey-box modelling approach employed in this work.

The remainder of this paper is organised as follows. Section 2 presents an outline of the grey-box modelling method and an explanation of the model development technique. In Section 3, the supermarket refrigeration system and available system data are described. Section 4 details the model development process, and model fitting and evaluation are addressed in Section 5. Conclusions and final remarks are presented in Section 6.

2 Grey-Box Modelling

2.1 Grey-Box Modelling Theory

Grey-box modelling facilitates the identification of models of dynamical systems using a combination of prior physical knowledge of the system under examination and information revealed by observed time series data. The grey-box modelling method benefits from the advantages of both white- and black-box modelling; capturing potential non-linear behaviour typically considered with white-box models derived from first principles, and accounting for both process and measurement noise, which are considered in black-box models [Kristensen et al., 2004]. A grey-box model consists of a set of SDEs that describe a dynamical system, and a measurement equation. Together these form a continuous-discrete time stochastic state-space model, where the discrete measurement equation describes how the measured data relates to the states of the system.

An initial, simplified, model of a display case system is presented here as an illustration of the format of a grey-box model. Fig. 1 shows the electric-thermal equivalent RC-representation of a first order model of the system. All of the models explored in this work consider the system as a set of lumped thermal bodies, such models are known as lumped parameter models. T_r and T_a are measured inputs to the model, the refrigerant temperature and the ambient temperature respectively. C_i is the thermal capacity of the interior of the display case, which in this case includes its structure, the food being displayed and the air circulating in the interior of the case. R_{ri} and R_{ia} represent the thermal resistance between the interior and the refrigerant, and the interior and the supermarket ambient air respectively. AKV is the opening degree of the expansion valve, this is the control variable that governs the variations in temperature within the display case. It is a system input given as a percentage, and α is a scaling parameter. This model assumes that all heat exchange occurs through the internal air, T_i , with heat exchange between the refrigerant and the interior, and the interior and the ambient, but no direct exchange of heat between the refrigerant and the ambient. This can be represented in the form of a stochastic state-space model as:

$$dT_i = \left(\frac{1}{C_i R_{ri}} (T_r - T_i) + \frac{1}{C_i R_{ia}} (T_a - T_i) - \frac{1}{C_i} AKV \alpha \right) dt + \sigma d\omega , \quad (1)$$

$$Y_t = T_{i,t} + \varepsilon_t , \quad \varepsilon_t \sim \mathcal{N} \left(0, \sigma_\varepsilon^2 \right) . \quad (2)$$

The $\sigma d\omega$ term in (1) represents the process noise, where ω is a Wiener process, and σ^2 is the incremental variance of this process. This representation of the process noise is referred to as the diffusion term, while the representation of the dynamics of the system (the remainder of (1)) is the drift term. The

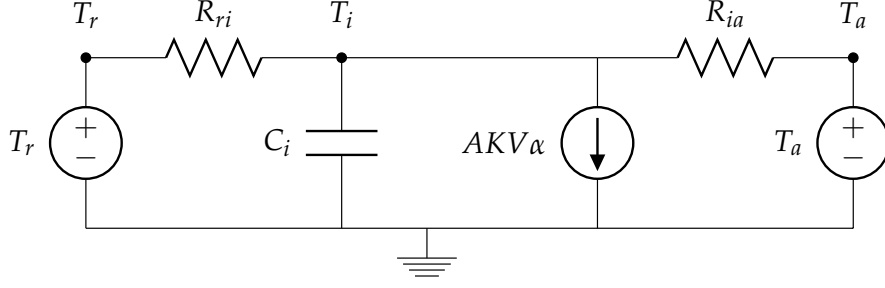

FIGURE 1: RC-Representation of the initial display case model (T_i)

measurements as represented by (2), are encumbered with measurement noise, ε_t . This is assumed to be a Gaussian distributed white noise process that is independent of the process noise.

The $R_{xx'}$, C_x , α , and noise parameters of the model must be determined by fitting the described model to the data, where x and x' refer to arbitrary and distinct model states, as specified in the models that follow. The maximum likelihood method is employed to fit the parameters. Maximum Likelihood Estimates (MLE) of the parameters are found by maximising the likelihood function of the parameters given the provided measurements. The likelihood function is:

$$L(\boldsymbol{\theta}, \mathcal{Y}) = p(\mathcal{Y}|\boldsymbol{\theta}) \quad (3)$$

where $\boldsymbol{\theta}$ is a vector containing the model parameters, and \mathcal{Y} is a vector of the measured data. By finding the parameters that maximise this expression, we find the parameters for the model described by (1) which are most likely to generate the observed data, including process and measurement noise.

The observations are denoted as:

$$\mathcal{Y}_{\mathbf{N}} = [Y_{\mathbf{N}}, Y_{\mathbf{N}-1}, \dots, Y_1, Y_0] \quad (4)$$

The likelihood can be expressed as a product of conditional densities:

$$L(\boldsymbol{\theta}; \mathcal{Y}_{\mathbf{N}}) = \left(\prod_{k=1}^{\mathbf{N}} p(Y_k | \mathcal{Y}_{\mathbf{k}-1}, \boldsymbol{\theta}) \right) p(Y_0 | \boldsymbol{\theta}) \quad (5)$$

where $p(Y_k | \mathcal{Y}_{\mathbf{k}-1}, \boldsymbol{\theta})$ is the conditional density describing the probability of generating the current observation, given the previous observations and the parameters set $\boldsymbol{\theta}$. The initial conditional densities, $p(Y_0 | \boldsymbol{\theta})$, are evaluated based on the estimation of the initial state of the system. The conditional densities in (5) are Gaussian, following from the fact that the noise processes are Gaussian and the system equations are linear.

Due to this, an ordinary Kalman filter can be used to evaluate the likelihood function and consequently find the MLE, $\hat{\boldsymbol{\theta}}$, of the unknown parameters. An optimisation function can then be used in conjunction with the Kalman filter to determine the parameter values that maximise the likelihood function. In this work, the software tool CTSM-R (Continuous Time Stochastic Modelling in R) [Juhl, 2013] is employed to estimate these parameters. Detailed discussion on the mathematics behind this tool, and the maximum likelihood method, can be found in [Kristensen et al., 2004] and [Madsen and Thyregod, 2010].

2.2 Model Development Process

A forward selection approach (see [Madsen and Thyregod, 2010] for detailed discussion) is adopted in this work, similar to the approach used by Bacher and Madsen [2011]. Modelling commences with the simplest feasible model, and additional complexity is introduced until the point where no significant improvement is found. Model complexity refers to the number of states and parameters in the model. The simplest feasible model is that given in (1) and (2); this is further developed by including additional states to represent more dynamics in the system and additional parameters to reflect different relationships between the states. The relative performance of candidate models is considered in terms of selected error metrics; the mean absolute error (MAE), root mean squared error (RMSE), and model bias. These fit statistics consider the one-step prediction error of each of the models, where each step corresponds to one minute. This is in line with the focus in this work on models for control rather than longer-term forecasting.

The likelihood ratio test and the log-likelihood value [Madsen and Thyregod, 2010] are alternative metrics that are commonly adopted when comparing models, for an example see [Bacher and Madsen, 2011]. This approach is not adopted in this work for two reasons; first, sequential iterations of model development do not always involve nested models, rendering the likelihood ratio test inapplicable; secondly, not all models explored here are structurally identifiable, meaning that the parameter values found by the CTSM-R solver are locally optimal but not necessarily globally optimal. Non-identifiability is not a major concern for models for control as the physical meaning of the parameters is not relevant. The determined parameter values and model structure govern the dynamics of the system, and it is not necessary for them to reflect the actual physical construction of the system.

The model selection process is conducted in three stages: fitting, validation and testing. A separate dataset is employed for each stage, where the data used for model fitting contains twice as many observations as each of the sets used for validation and testing, as recommended by Hastie et al. [2001]. The fitting step involves the fitting of parameters to a large number of models. In the validation step only a subset of the models are considered; the model structures and corresponding parameters found in the fitting step are retained and the performance of the selected models is compared using the error metrics detailed above. Finally, the model with the best performance on the validation dataset is tested using the testing dataset; the purpose of this test is to assess the generalization error of the model. The testing stage is necessary to ensure that the model has not been over-fit. In all cases (fitting, validation and testing) the model performance is defined by the one-step prediction error. As the models are being employed for control purposes, it is intended that the selected model will adapt with the system. Therefore, it is not necessary that a particular model performs as well in the testing step as in the fitting step, however it is a useful indicator of the general performance of the model.

3 Description of System and Data

3.1 System Description

The system considered in this paper is a small supermarket located on the island of Funen, in Denmark. The refrigeration system consists of 7 medium temperature (above freezing) display cases and 4 low temperature (below freezing) units. Two compressor banks power the refrigeration system, and are arranged in a booster configuration.

The refrigeration system operates in a hierarchical control structure. Supervisory control determines the operation of the larger system, consisting of the compressor banks, fans, the condenser and the suction manifold, such that a desired refrigerant temperature at the input to the medium and low temperature display units can be achieved. The food display units are mounted in parallel, each of the medium temperature units and each of the low temperature units have the same refrigerant temperature at the input to their (individual) evaporators. Local control at each display unit ensures that temperature limits are respected by modulating the degree to which the expansion valves in the individual evaporators are open.

Each display unit has distinct characteristics and thermal interactions, as a result of differing temperature bounds and different foodstuffs being stored. A single unit is modelled in this work, however the modelling approach employed here can be used to identify models for each unit. The local control at the level of the display case is the focus of this paper; currently it resembles hysteresis control, where the temperature continually oscillates between upper and lower limits. This is a simplistic approach that is acceptable in the current, passive, systems, however as the overall system becomes activated through intelligence it will be advantageous to have more precise temperature control within the display cases, such that the system as a whole can operate optimally. Fig. 2 provides a simplified schematic of the display case system, the distinct control regions, and the link to the power system.

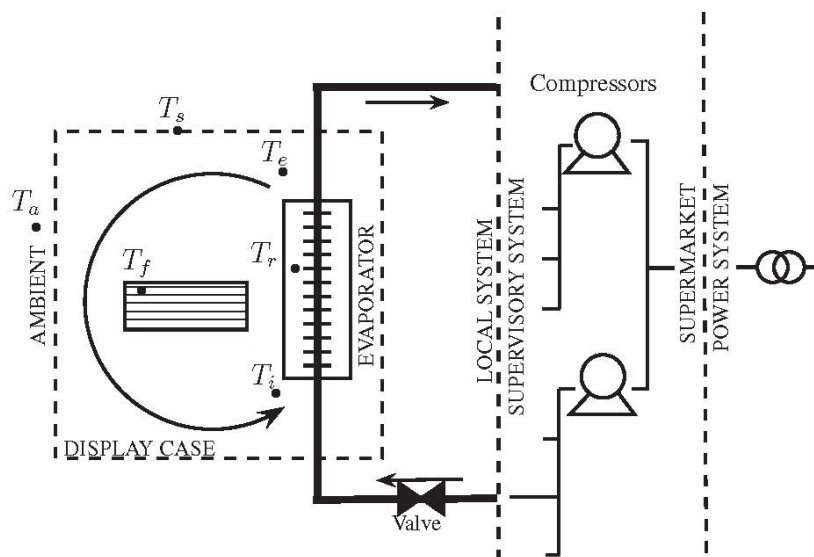

FIGURE 2: Simplified graphical representation of the display case system, including the local control system, the supervisory control system and the link to the power system.

There are a number of complexities in the operation of the system that complicate the task of modelling its thermal behaviour. Each of the display units undergoes numerous defrosting operations during the day, where the temperature within the unit is raised above the typical operating range to allow any accumulated ice to melt. Furthermore, there is an observable difference in how the system operates during shop opening hours compared to the night-time period. This regime change can be explained by the insulating covers placed on display units outside of opening hours. Stochasticity in the system is the result of the random addition and removal of foodstuff in the system, and the thermal interactions with passing customers and staff.

3.2 System Data

Data was recorded at multiple locations in the supermarket refrigeration system. Temperature sensors were placed within the display units; the refrigerant temperature, the temperatures of the air at the inlet and outlet of the evaporator, and the opening degree of the expansion valves are reported for each display unit. General system data is also available, including the ambient air temperature within the supermarket, the external air temperature, refrigerant mass flows throughout the system, and the power consumption of each of the compressor banks. All of the data series were recorded at a resolution of one minute. The models developed in this work are based on data recorded over 3 24-hour periods in October 2010. The three datasets used for fitting, validation and testing correspond to consecutive Wednesdays. These dates were selected to ensure reasonably similar system conditions in all datasets. Large deviations in system conditions can be handled by adaptively fitting the model parameters during operation.

Fig. 3 presents the training dataset employed to establish a grey-box model of the open medium tem-

perature display unit considered in this paper. The uppermost plot shows the development of three key temperatures in the display unit over 24 hours on the 10th of October 2010. The internal temperature represents the temperature to be controlled within the display unit; this is the temperature most commonly monitored by supermarket operators and food regulatory bodies, and is consequently required to remain strictly within set limits.

The evaporator temperature is the temperature of the air exiting the evaporator. The dynamics of these two temperatures are very similar; the evaporator exhibits more extreme temperature variations, as the evaporator temperature drives the internal temperature in the display unit, and is subject to thermal losses to a number of sources. The blue trace shows the temperature of the refrigerant in the system. This is common for all of the medium temperature display units, and is a fixed input, as determined by the supervisory control of the system. The second plot in the figure indicates the instances of defrost operation for the considered display case, and the hours during which the supermarket is closed. The impact of these factors on the temperatures in the display unit can be observed in the first plot, with spikes in temperatures during defrost operations and notably different temperature trends when the supermarket is closed. This day/night difference can also be observed in the expansion valve time series displayed in the third plot. During the night the unit benefits from increased insulation from an insulating cover as well as decreased ambient air temperature, consequently the expansion valve is not opened as frequently or for as long as occurs during the day. This change is also reflected in the temperature plots, where the dynamics are notably slower outside of the supermarket opening hours. The degree to which the expansion valve is open determines the temperature within the display unit (subject to the refrigerant and ambient temperatures), it is the control variable in the local control system.

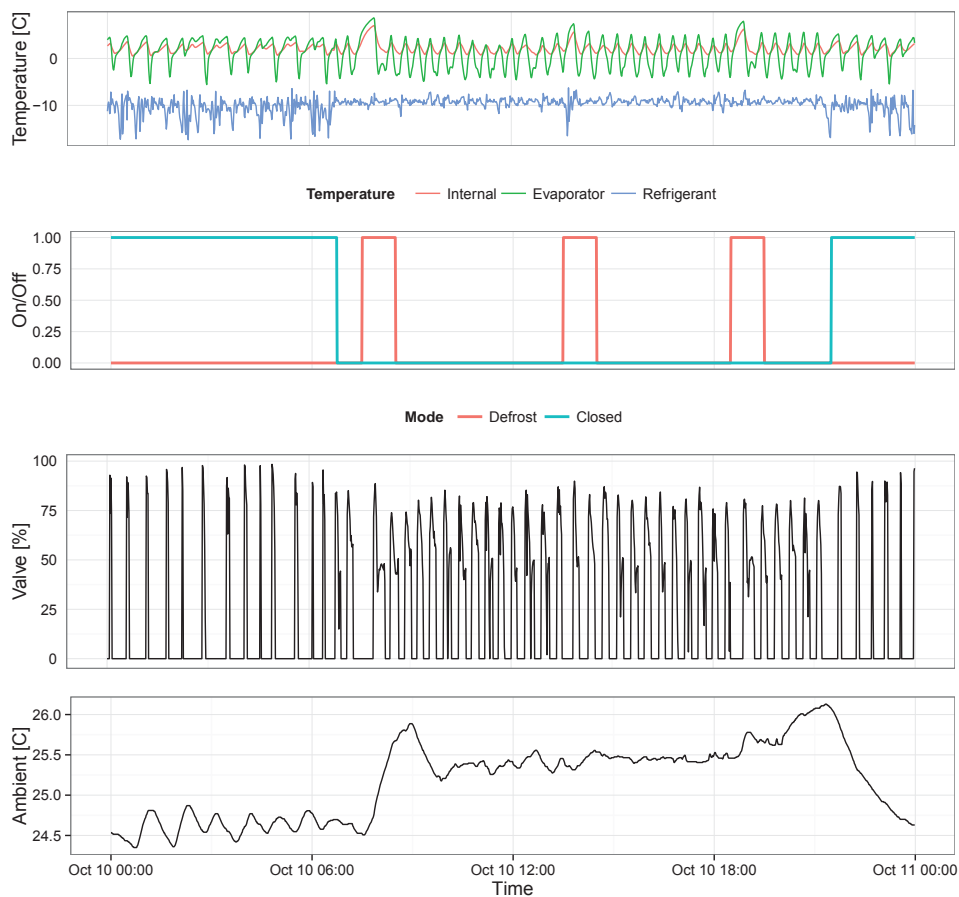

FIGURE 3: Temperature, environmental (open/closed status, defrost status, ambient temperature) and control input (valve) data for an open medium temperature display case in a supermarket in Funen, Denmark

4 Model Development

The derivation of a grey-box model of the display case system is detailed in this section. The system temperatures considered in this work include that of the refrigerant (T_r), the ambient air in the supermarket (T_a) (both known model inputs) and four temperatures in the interior of the fridge; the air at the evaporator outlet (T_e), the food (T_f), the air within the display case (T_i), and the temperature of the display structure (T_s). Only the model inputs and the air temperature within the display case are known when fitting the models, the other temperatures are modelled as hidden states.

The models are presented in order of increasing complexity. Models of two, three and four states are presented in the following sub-sections. A number of different configurations of the described models were tested, with the most successful presented in detail. The performance of the alternative models is given in tabular form in the results section which follows, with the electric-thermal equivalent RC-representations provided in Appendix A.

4.1 Model $T_i T_e$

The two-state (T_i, T_e) model shown in Fig. 4 considers that the dynamics of the system are governed by the thermal masses in the interior of the unit (T_i) and at the outlet of the evaporator (T_e). In this model the impact of the expansion valve operation is considered to directly affect the temperature at the evaporator outlet. Heat exchange from the refrigerant to the ambient occurs through the evaporator and the interior of the display unit, in sequence, with no direct heat exchange between the refrigerant or the evaporator outlet with the ambient.

The two-state stochastic model of this system is given by:

$$dT_i = \left(\frac{1}{C_i R_{ei}} (T_e - T_i) + \frac{1}{C_i R_{ia}} (T_a - T_i) \right) dt + \sigma_1 d\omega_1, \quad (6)$$

$$dT_e = \left(\frac{1}{C_e R_{re}} (T_r - T_e) + \frac{1}{C_e R_{ei}} (T_i - T_e) - \frac{1}{C_e} AKV\alpha \right) dt + \sigma_2 d\omega_2, \quad (7)$$

$$Y_t = T_{i,t} + \varepsilon_t, \quad \varepsilon_t \sim \mathcal{N}(0, \sigma_\varepsilon^2). \quad (8)$$

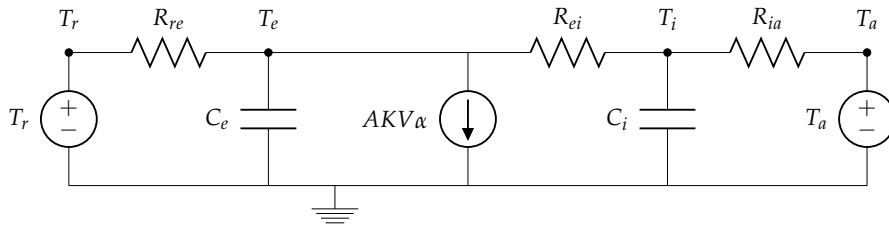

FIGURE 4: RC-Representation of a two time constant model ($T_i T_e$)

4.2 Model $T_i T_e T_f$

Additional complexity is added to the model from Subsection 4.1 by considering the thermal capacitance of the food, C_f . The simplest three-state (T_i, T_e, T_f) model is shown in Fig. 5, and comprises of thermal links between the refrigerant, the air at the evaporator outlet, the internal air, the food, and the ambient supermarket air, in sequence. Alternative considered configurations of this three state model include the addition of a thermal link between the internal air and the supermarket ambient. This is an intuitive

development as not all thermal energy can be expected to flow through the foodstuffs to the ambient, and a degree of direct leakage of energy from the interior to the ambient is expected. Three further model configurations consider inputs indicating the open/closed state of the supermarket and the instances of defrosting operations. Full details of these alternative configurations are provided in Appendix 6. Fig. 5 illustrates the model in the form of an electric-thermal equivalent circuit, and the three-state stochastic model of the system is as follows.

$$dT_i = \left(\frac{1}{C_i R_{ei}} (T_e - T_i) + \frac{1}{C_i R_{if}} (T_f - T_i) \right) dt + \sigma_1 d\omega_1, \quad (9)$$

$$dT_e = \left(\frac{1}{C_e R_{re}} (T_r - T_e) + \frac{1}{C_e R_{ei}} (T_i - T_e) - \frac{1}{C_e} AKV\alpha \right) dt + \sigma_2 d\omega_2, \quad (10)$$

$$dT_f = \left(\frac{1}{C_f R_{if}} (T_i - T_f) + \frac{1}{C_f R_{fa}} (T_a - T_f) \right) dt + \sigma_3 d\omega_3, \quad (11)$$

$$Y_t = T_{i,t} + \varepsilon_t, \quad \varepsilon_t \sim \mathcal{N}(0, \sigma_\varepsilon^2). \quad (12)$$

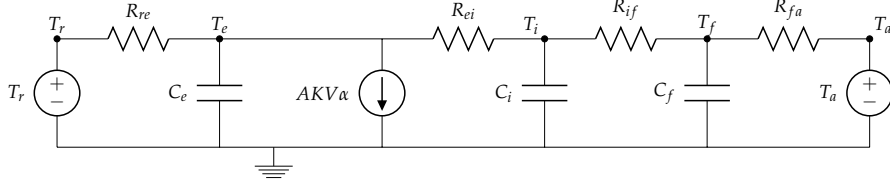

FIGURE 5: RC-Representation of a three time constant model ($T_i T_e T_f$)

4.3 Model $T_i T_e T_f T_s$

Finally, additional complexity is added by considering that the dynamics of the system may not be fully accounted for by the three states used in the previous models. A further state, T_s , is added. There is no intuitive interpretation of this state as any particular component of the display case unit, however it could be considered to be any number of possible components, including the structure of the unit. Furthermore, as the model is based on a lumped parameter approximation of a distributed system, the addition of an additional state could correspond to the better representation of an aspect of the model that was previously represented by a single state; for example, the food may be better represented by individual states for the inner and outer sections of the foodstuff. Fig. 6 shows the configuration of this model in its electric-thermal equivalent circuit form. The four-state stochastic model of the system is:

$$dT_i = \left(\frac{1}{C_i R_{si}} (T_s - T_i) + \frac{1}{C_i R_{if}} (T_f - T_i) \right) dt + \sigma_1 d\omega_1, \quad (13)$$

$$dT_e = \left(\frac{1}{C_e R_{re}} (T_r - T_e) + \frac{1}{C_e R_{es}} (T_s - T_e) - \frac{1}{C_e} AKV\alpha \right) dt + \sigma_2 d\omega_2, \quad (14)$$

$$dT_f = \left(\frac{1}{C_f R_{if}} (T_i - T_f) + \frac{1}{C_f R_{fa}} (T_a - T_f) \right) dt + \sigma_3 d\omega_3, \quad (15)$$

$$dT_s = \left(\frac{1}{C_s R_{es}} (T_e - T_s) + \frac{1}{C_s R_{si}} (T_i - T_s) \right) dt + \sigma_4 d\omega_4, \quad (16)$$

$$Y_t = T_{i,t} + \varepsilon_t, \quad \varepsilon_t \sim \mathcal{N}(0, \sigma_\varepsilon^2). \quad (17)$$

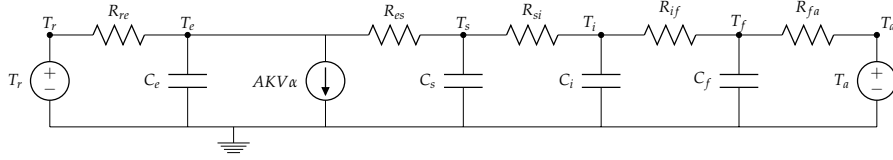

FIGURE 6: RC-Representation of a four time constant model ($T_i T_e T_f T_s$)

No further complexity is considered in the modelling process as the four-state model is found to provide no significant improvement over the three-state model, as discussed in the following section. Furthermore, the residuals of the three-state model show no systematic pattern that would have called for a further state or time constant.

5 Results

The adequacy and performance of the models detailed in the preceding section is evaluated here. Model adequacy is assessed by analysing the model errors. If the one-step prediction errors for a particular model show a systematic pattern, this indicates an extension of the model is necessary. If, on the other hand, the residuals resembles white-noise, it can be concluded that there is no information in the data than contradicts the conclusion that the particular model adequately describes the system. This criterion for model adequacy is checked by examining the histogram, auto-correlation function (ACF) and the cumulative periodogram for each of the models in the fitting stage. The performance of the models is assessed by comparing their error metrics; the RMSE, MAE and bias.

Fig. 7 shows the ACF for the simplest, single-state, stochastic model, as presented in Section 2. It is very clear that the residuals of this model are not Gaussian distributed, and thus the model is inadequate. The histogram reveals a positive bias in the model, and the behaviour of ACF indicates that there are additional time constants in the system that are not accounted for by this model.

A significant improvement is achieved by adding an additional time constant to the model ($T_i T_e$), however the resulting model residuals are still not Gaussian distributed, indicating the need for additional modelled states.

Fig. 8 shows that the residuals of the three-state model, $T_i T_e T_f$, can be said to be normally distributed, indicating that this model represents the dynamics of the observed system adequately. Similar results are found for the residuals of the four-state model, $T_i T_e T_f T_s$, thus the benefit of increasing the model complexity to four-states must be evaluated by considering the error metrics.

Table 1 provides the error metrics for each of the models described above, as well as some of the alternative configurations that were explored, as presented in Appendix A. The model selection process involves the addition of model complexity through alternative configurations and additional states (and correspondingly, time constants). The models are grouped according to the number of time constants, denoted i in Table 1, and compared considering the number of parameters, m . Error metrics are presented in both absolute and relative terms, where the current model is compared to the most successful model with one less time constant (as highlighted in red); for example, model $T_i T_e T_f$, with three states, is compared to model $T_i T_e$, the best performing two-state model. The best performing models at each iteration of the model development process were selected by considering both their error metrics and the ACF, cumulative periodogram and histogram. These models (excluding model T_i) were retained for

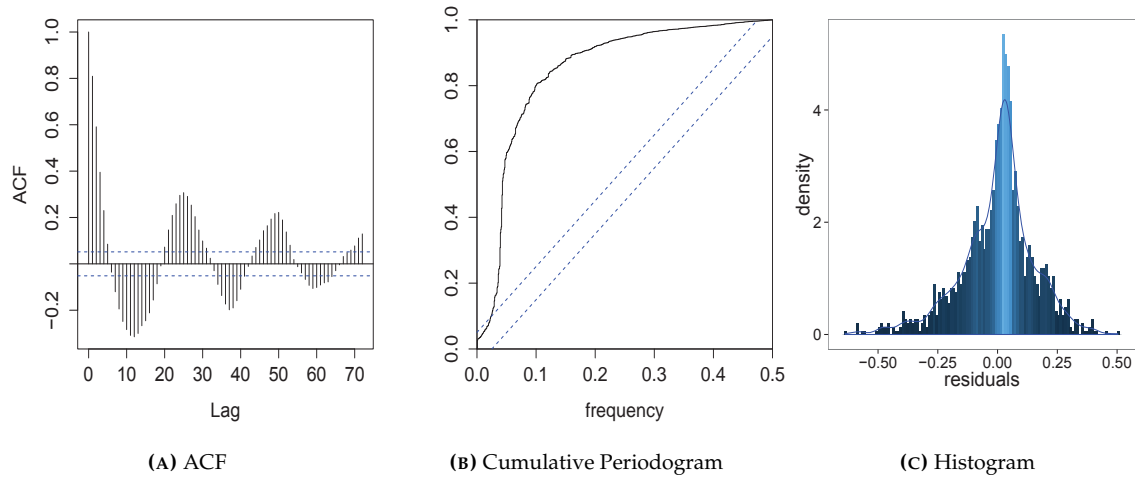

FIGURE 7: Analysis of the residuals of a single-state model (T_i)

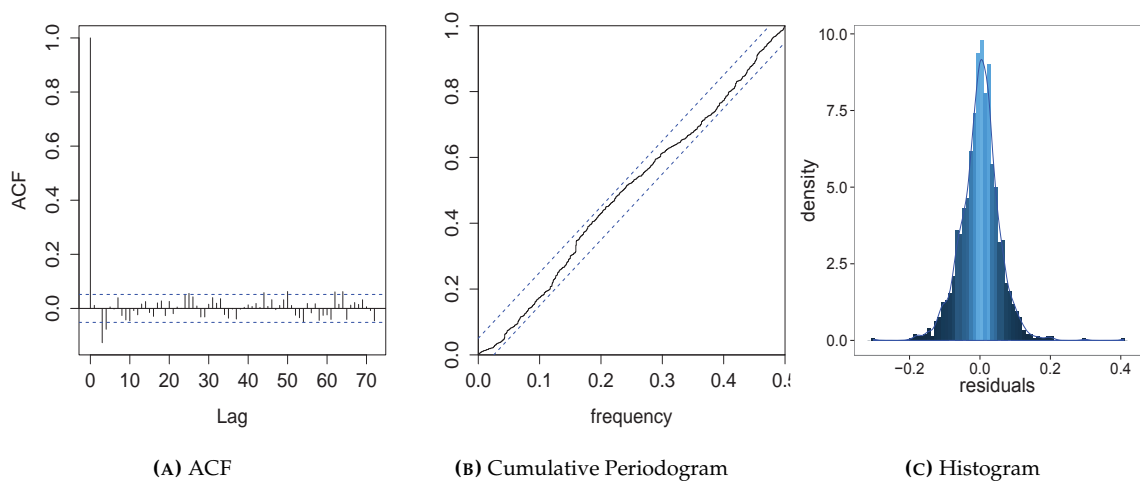

FIGURE 8: Analysis of the residuals of a three-state model ($T_i T_e T_f$)

the validation stage, all other models were discarded. It can be noted from Table 1 that the four-state model provides no significant improvement over the three-state model and consequently the model development process can be terminated at this stage.

TABLE 1: Error metrics for all models at the model fitting stage, where m denotes the number of parameters.

i	Model	m	Absolute [$^{\circ}\text{C}$]			Relative [%]	
			RMSE	MAE	Bias	RMSE	MAE
1	T_i	7	0.1549	0.1138	$7.03\text{e-}5$	-	-
2	T_iT_e	11	0.0577	0.0424	$-6.34\text{e-}4$	62.74	62.74
	$T_iT_eT_2$	11	0.0727	0.0508	$-1.69\text{e-}3$	53.07	55.36
	$T_iT_eT_3$	12	0.0577	0.0424	$-6.21\text{e-}4$	62.76	62.76
3	$T_iT_eT_f$	15	0.0556	0.0407	$2.47\text{e-}4$	3.85	4.02
	$T_iT_eT_fT_2$	16	0.0556	0.0408	$1.28\text{e-}4$	3.69	3.63
	$T_iT_eT_fN$	16	0.0558	0.0407	$-2.15\text{e-}4$	3.23	4.01
	$T_iT_eT_fN_2$	17	0.0559	0.0407	$-2.12\text{e-}4$	3.22	4.01
	$T_iT_eT_fND$	18	0.0558	0.0407	$-2.02\text{e-}4$	3.26	3.99
4	$T_iT_eT_fT_s$	19	0.0560	0.0407	$1.15\text{e-}4$	-0.08	0.09

5.1 Validation Stage

Fig. 9 shows the cumulative periodograms of the residuals of each of the models when validated using the validation dataset (retaining the model parameters determined in the model fitting stage). Table 2 provides the error metrics for this validation. By considering both the proximity of the residuals to white noise, and the error metrics, it can be seen that model $T_iT_eT_f$ is the best candidate. This model most closely represents the observed dynamics of the display unit system.

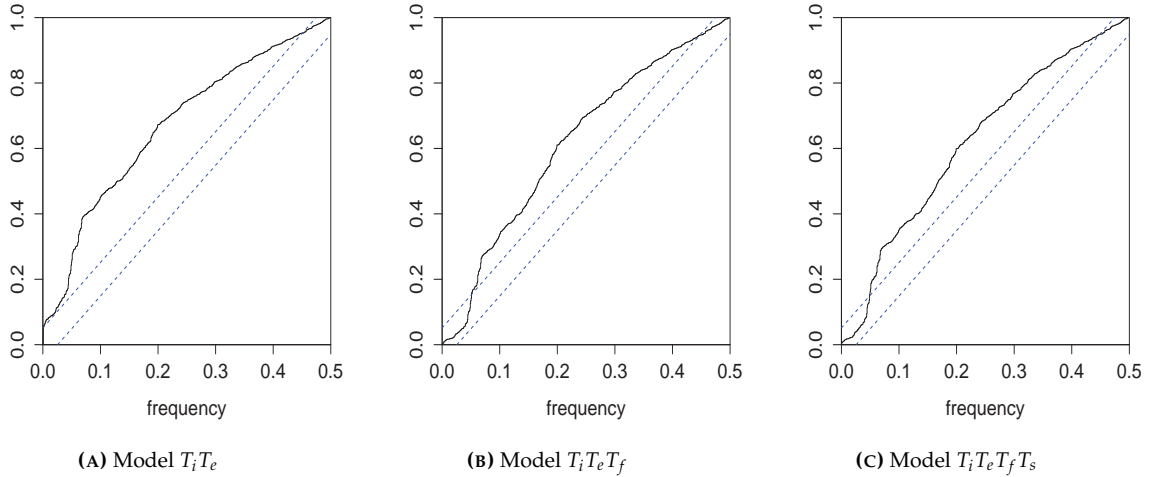

FIGURE 9: Cumulative periodograms of the residual of the models selected for advancement to the validation stage, using the validation dataset

TABLE 2: Error metrics for models at the model validation stage

Model	RMSE [$^{\circ}\text{C}$]	MAE [$^{\circ}\text{C}$]	Bias [$^{\circ}\text{C}$]
T_iT_e	0.069	0.047	$6\text{e-}3$
$T_iT_eT_f$	0.064	0.043	$1.9\text{e-}3$
$T_iT_eT_fT_s$	0.066	0.044	$2.1\text{e-}3$

5.2 Testing Stage

Model $T_i T_e T_f$ is tested using testing dataset. Fig. 10 shows the performance of this model. Although the residuals are clearly not white noise, the performance is satisfactory considering that the parameters were fit using a completely separate dataset. Most interestingly, the model performs better with the test dataset than with the validation dataset. This suggests that the generalisation error is very low. The MAE, RMSE and Bias in this case are 0.0664, 0.0424 and $-3.5e-3$ respectively.

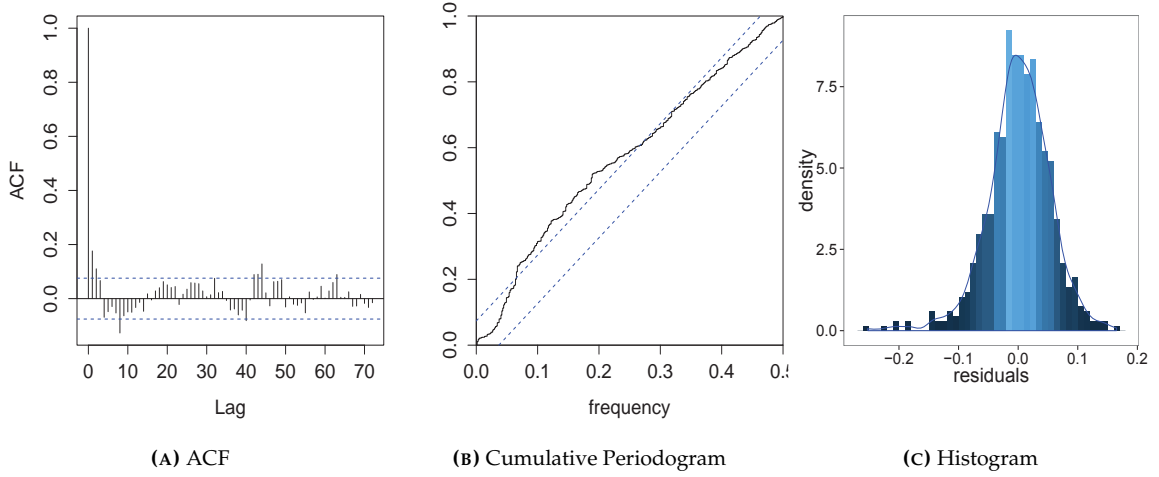

FIGURE 10: Analysis of the residuals of the three state model ($T_i T_e T_f$) using the test dataset

6 Conclusions

A grey-box model describing the dynamics of a supermarket refrigeration display case has been developed in this work. The system is described by stochastic differential equations, reflecting the inherent stochasticity of a system with randomly occurring stimuli, including the addition and removal of foodstuffs, and the opening and closing of unit doors. The model selection procedure is described in detail, commencing with the simplest feasible model and continuing with increasing complexity until no further significant improvement occurs. Models are compared using a defined set of metrics describing the model residuals, and model performance and generalization error are evaluated by employing three independent datasets for model fitting, validation and testing.

The results show that a three time constant model ($T_i T_e T_f$) is most appropriate for modelling the display case considered in this study. This model is specific to the display case considered here, and is not directly applicable to other display units, as the model is dependent on the foodstuff stored in the display case and the case structure, among other factors. Going forward, it would be advantageous for this modelling approach to be applied to a number of different display units in different supermarkets. The parameter values found in this work could be used as a priori information to provide a starting point for further model development.

The model developed in this work and the method employed to identify it have an important application in the development of novel local control strategies for supermarket refrigeration system. There is a particular relevance considering the focus on model-based control frameworks within the field of demand response. Advanced control strategies beyond the current hysteresis approach will enable greater flexibility throughout the refrigeration system. This is a key contribution towards achieving overall flexibility of power consumption of the supermarket refrigeration system. This has advantages for both the supermarket and power system operators; allowing the supermarket operator to optimise operations towards cost- or energy-efficiency, and facilitating the participation of demand in the electricity market and for the provision of power system services.

Acknowledgment

The work presented here has been partly funded by CITIES (DSF - 1305-00027B). We are thankful to the Danish Council for Strategic Research for this support.

References

- P. Andersen, M. Jimenez, H. Madsen, and C. Rode. Characterization of heat dynamics of an arctic low-energy house with floor heating. *Building Simulation*, 7(6):595–614, 2014. ISSN 1996-3599. URL <http://dx.doi.org/10.1007/s12273-014-0185-4>.
- D. Angeli and P.-A. Kountouriotis. A stochastic approach to dynamic-demand refrigerator control. *IEEE Transactions on Control Systems Technology*, 20(3):581–592, 2012. ISSN 1063-6536.
- J. Arias. *Energy Usage in Supermarkets - Modelling and Field Measurements*. Doctoral Thesis, Division of Applied Thermodynamics and Refrigeration, Department of Energy Technology, Royal Institute of Technology Stockholm, 2005.
- P. Bacher and H. Madsen. Identifying suitable models for the heat dynamics of buildings. *Energy and Buildings*, 43:1511–1522, 2011.
- O. Corradi, H. Ochsenfeld, H. Madsen, and P. Pinson. Controlling electricity consumption by forecasting its response to varying prices. *IEEE Transactions on Power Systems*, 28(1):421–429, 2013. ISSN 0885-8950. doi: 10.1109/TPWRS.2012.2197027.
- G. T. Costanzo, F. Sossan, M. Marinelli, P. Bacher, and H. Madsen. Grey-box modeling for system identification of household refrigerators: A step toward smart appliances. In *4th International Youth Conference on Energy (IYCE)*, pages 1–5, 2013.
- R. Furberg and C. Norberg. Energy efficiency in supermarkets - project work in business, technology and leadership, 2000. Royal Institute of Technology, Stockholm.
- R. Halvgaard, N. Poulsen, H. Madsen, and J. Jørgensen. Thermal storage power balancing with model predictive control. In *European Control Conference (ECC)*, pages 2567–2572, 2013.
- T. Hastie, R. Tibshirani, and J. Friedman. *The Elements of Statistical Learning*. Springer, 2001.
- T. Hovgaard, L. Larsen, J. Jørgensen, and S. Boyd. Nonconvex model predictive control for commercial refrigeration. *International Journal of Control*, 86(8):1349–1366, 2013. ISSN 0020-7179.
- R. Juhl. CTSM for R, 2013. URL www.ctsm.info. R package version 0.6.6-2.
- N. R. Kristensen, H. Madsen, and S. B. Jørgensen. Parameter estimation in stochastic grey-box models. *Automatica*, 40:225–237, 2004.
- I. Lampropoulos, P. van den Bosch, and W. Kling. A predictive control scheme for automated demand response mechanisms. In *3rd IEEE PES International Conference and Exhibition on Innovative Smart Grid Technologies (ISGT Europe)*, pages 1–8, 2012.
- H. Madsen and P. Thyregod. *Introduction to General and Generalised Linear Models*. Chapman & Hall/CRC, 2010.
- P. Nyeng, J. Ostergaard, M. Tøgeby, and J. Hethey. Design and implementation of frequency-responsive thermostat control. In *45th International Universities Power Engineering Conference (UIPEC)*, pages 1–6, 2010.
- F. Oldewurtel, A. Parisio, C. Jones, D. Gyalistras, M. Gwerder, V. Stauch, B. Lehmann, and M. Morari. Use of model predictive control and weather forecasts for energy efficient building climate control. *Energy and Buildings*, 45(0):15 – 27, 2012. ISSN 0378-7788. URL <http://www.sciencedirect.com/science/article/pii/S0378778811004105>.
- R. Pedersen, J. Schwensen, S. Sivabalan, C. Corazzol, S. Shafiei, K. Vinther, and J. Stoustrup. Direct control implementation of a refrigeration system in smart grid. In *American Control Conference (ACC)*, pages 3954–3959, 2013.
- R. Pedersen, J. Schwensen, B. Biegel, J. Stoustrup, and T. Green. Aggregation of supermarkets as demand side devices in a smart grid. In *Proceedings of the 19th World Congress of the International Federation of Automatic Control*, Cape Town, South Africa, 2014.
- S. E. Shafiei, H. Rasmussen, and J. Stoustrup. Modeling supermarket refrigeration systems for demand-side management. *Energies*, 6:900–920, 2013.

Appendix A: Equivalent RC-Networks of Models Investigated

The additional model configurations not detailed in the main body of this paper are presented here. Four further variables are introduced in the circuits below; βN introduces the impact of opening/closing hours of the supermarket into the model, where N is a binary input to the model indicating the regime (open or closed) and β is a parameter that is fit; γD introduces the impact of defrosting operations into the model, where D is a binary input to the model indicating the regime (defrost or regular operation) and γ is a parameter that is fit.

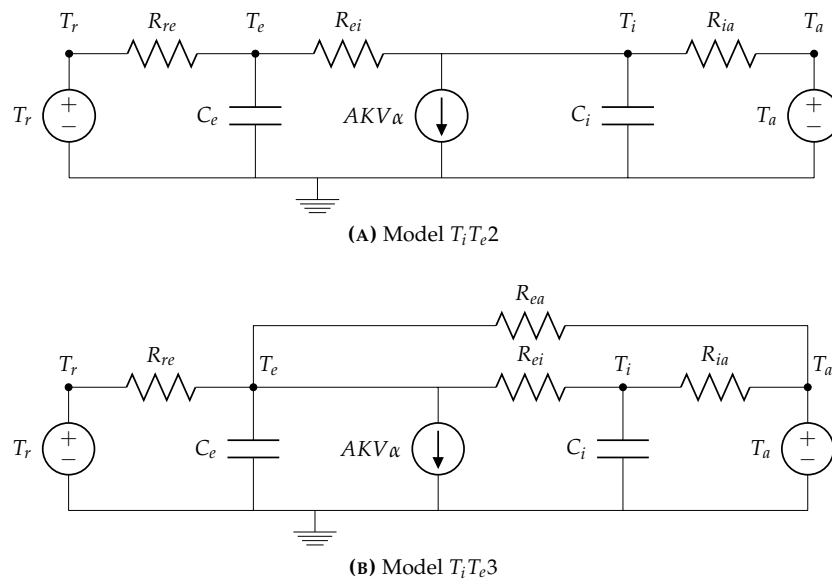
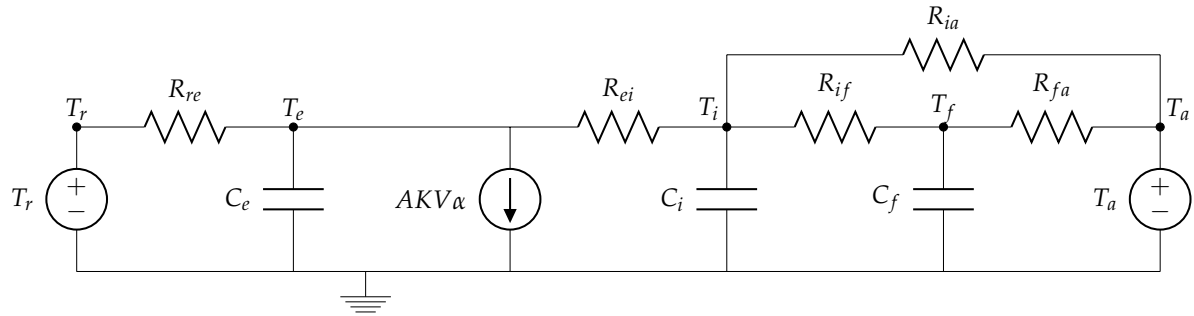
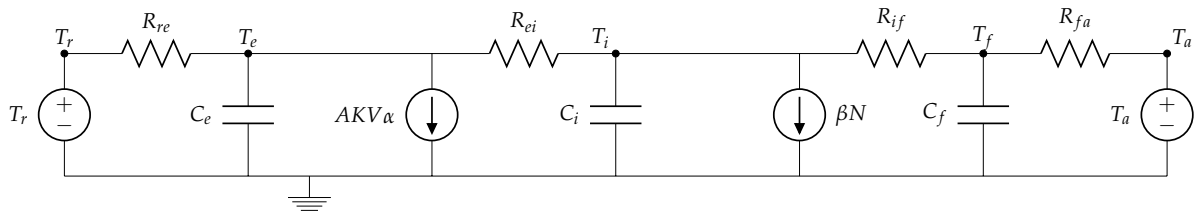

FIGURE 11: Alternative Model Configurations



(C) Model $T_i T_e T_f 2$



(D) Model $T_i T_e T_f N$

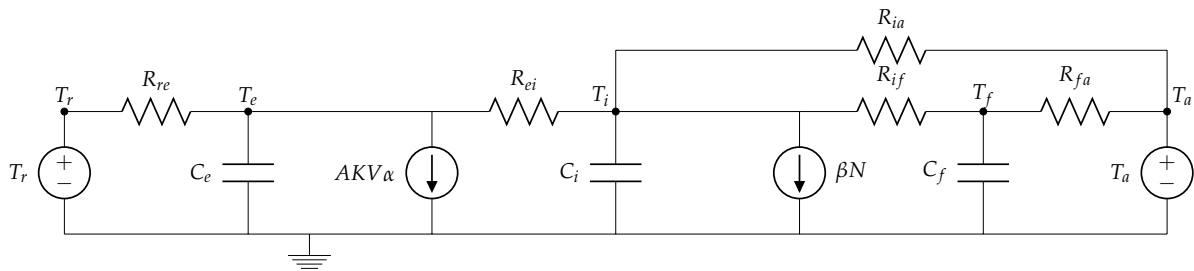

(E) Model $T_i T_e T_f N 2$

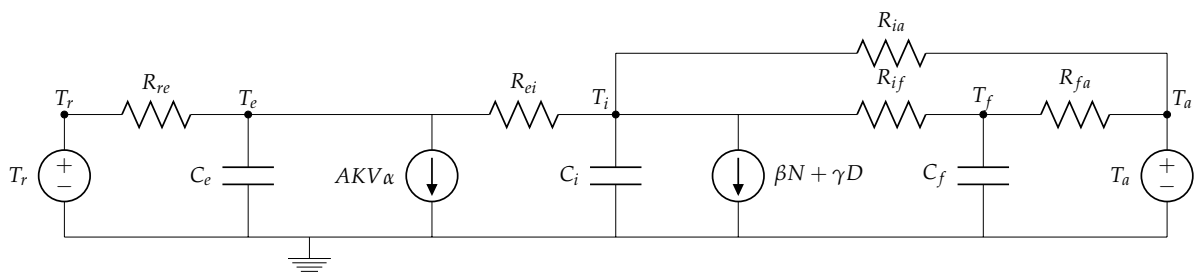

(F) Model $T_i T_e T_f N D$

FIGURE 10: Alternative Model Configurations